

# PANOS RADIUS Linea Led

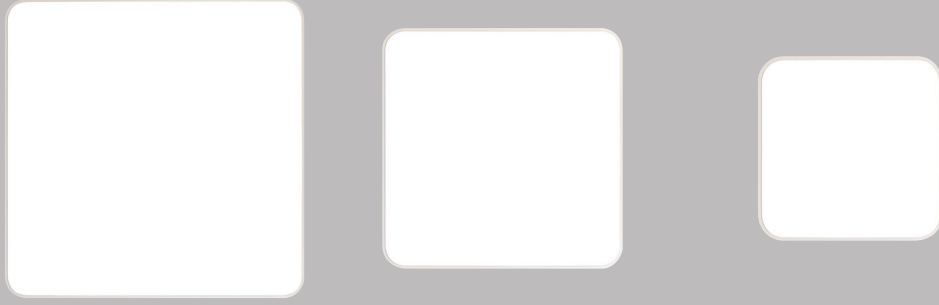



PANOS RADIUS designed for illuminating various work areas like offices, hospitals, clinics, schools, governmental buildings etc. Opal louvre in acrylic and also microprismatic version available for low UGR. Surface mounted and pendant versions available with both direct and direct/indirect light output.





SMD board technology inside this range designed to maximize the efficiency and homogeneity of the light output.

PANOS RADIUS ofis, okul, hastane, klinik, kamu binaları gibi birçok farklı projede tercih edilebilir. Opal diffüzör yapılı ve alternatif olarak düşük kamaşma sağlayan mikroprizmatik diffüzörlü seçeneği mevcuttur. Direkt ve Direkt/Endirekt sarkıt ve sivaüstü montaj seçenekleri mevcuttur.

Armatür içerisine uygulanan SMD Led teknolojisi hem maksimum verimlilik hem de mükemmel homojenliğe sahip görsel konfor sağlamak için tasarlanmıştır.

# Panos Radius

## DIM Options / DIM seçenekleri

					
	Panos Radius Susp. 40x40cm	Panos Radius Surface 40x40cm	Panos Radius Susp. 60x60cm	Panos Radius Surface 60x60cm	Panos Radius Susp. 80x80cm
ON-OFF	•	•	•	•	•
PHASE CUT DIM / FAZ DİM	Ext.Code / Kod: .PH				
1-10V DIM	Ext.Code / Kod: .VO				
DALI DIM	Ext.Code / Kod: .DA				
WIRELESS DIM / KABLOSUZ DİM	Ext.Code / Kod: .WD				
WARM DIM / SICAK DİM	Ext.Code / Kod: .WM				
TUNABLE WHITE / DİNAMİK BEYAZ	Ext.Code / Kod: .TW				

## Wireless DIM / Kablosuz DIM

Avolux offers wireless DIM control on its PANOS RADIUS range that provides easy control and saves time on wiring during installation.

Avolux PANOS RADIUS serisi armatürlerinde kablosuz DIM seçeneği sunarak kolay kontrol olanağı sunar. Ürün montaj kurulum esnasında daha az kablolama ile zamandan tasarruf sağlar.





## UGR Glare / UGR Kamaşma

PANOS RADIUS series provides UGR<22 which is an acceptable standart for offices, schools etc. With extra attachment of microprismatic diffuser in front of opal diffuser, UGR<19 low glare standart can be reached.

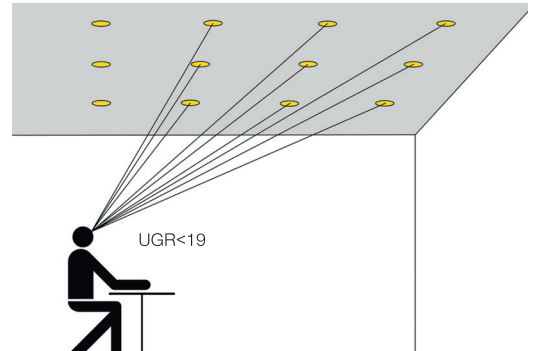
PANOS RADIUS serisi UGR<22 orta düzey kamaşma değerlerini sağlamaktadır. Bu standart okul, ofis gibi alanlarda kabul edilebilir bir seviyedir. Alternatif olarak opal diffüzör önüne ilave edilebilen microprismatic diffüzör sayesinde UGR<19 düşük kamaşma değerlerine ulaşılabilir.

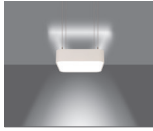

# Panos Radius

 Panos Radius Surface 80x80cm	 Panos Radius D/I 40x40cm	 Panos Radius D/I 60x60cm	 Panos Radius D/I 80x80cm
•	•	•	•
•	•	•	•
•	•	•	•
•	•	•	•
•	•	•	•
•	•	•	•

## Tunable White / Dinamik Beyaz

AVOLUX can apply Tunable White control to its PANOS RADIUS range. Via smart phone or bluetooth switch, individual control or grouping selections possible. Complex solutions can be easily performed.

Avolux PANOS RADIUS serisi armatürlerinde dinamik beyaz ışık kontrolü seçeneği sunmaktadır. Akıllı telefon veya bluetooth anahtarlar ile ışık kontrolü sağlanabilir. Armatürler tek tek veya grup halinde kontrol edilerek yüksek adetli armatür içeren projeler dahil kolaylıkla sisteme adapte edilebilir.



Android & iOS



Xpress



# Panos Radius Suspending

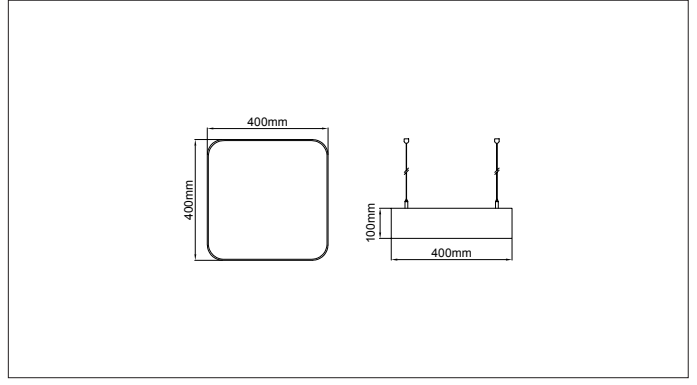

\* Code example / Kod örneği:

102.LL.25110.023.830.01

- 1- Product code / Armatür kodu
- 2- Power / Güç
- 3- CRI / Kelvin
- 4- Colour / Ürün renk
- 5- Control type / Kontrol tipi

4 / Product Color / Ürün Renk



Beam Angle / Işık Açısı

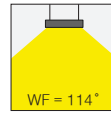

Suspension Wire

Sarkıtma Teli



## Description / Tanım

Aluminium body. Opal or microprismatic diffuser options available. Mains voltage: 220-240V / 50-60Hz. 1-10V, DALI, Casambi DIM, Tunable White DALI, Tunable White CASAMBI, options available. Emergency kit system can be integrated. Basic colours: white, black, silver, antracite dark gray and special color options available upon request. Steel suspension wire with up to 5mt length option together with standart or central baldachine.

Alüminyum gövde. Opal veya mikroprizmatik difüzör seçenekleri mevcuttur. Şebeke gerilimi: 220-240V / 50-60Hz. 1-10V, DALI, Casambi DIM, Dinamik Beyaz DALI, Dinamik Beyaz CASAMBI seçenekleri mevcuttur. Acil durum kiti sistemi entegre edilebilir. Temel renkler: beyaz, siyah, gümüş, antrasit koyu gri ve istek üzerine özel renk seçenekleri mevcuttur. Standart veya merkezi baldachine ile birlikte 5mt'ye kadar uzunluk seçeneği ile çelik asma teli.

## Product Data / Ürün Bilgileri

Article Nr. (AVOLUX)	102.LL.25110.(Power).(CRI).(Colour)
Material / Malzeme	Aluminium
Outer Diameter / Dış Çap	40x40cm
Height / Yükseklik	100mm
Weight / Ağırlık	2.5kg
Mouting method / Montaj yöntemi	Suspending / Sarkıt

## Lighting Technology / Aydınlatma Teknolojisi

Colour Temperature / Renk Sıcaklığı	2700K	3000K	3500K	4000K	5000K
Luminous flux / Işık akısı	2593lm	2676lm	2717lm	2821lm	2862lm
System efficiency / Sistem verimliliği	113lm/W	116lm/W	118lm/W	123lm/W	124lm/W
Colour rendering / Renk oluşturma	80CRI	80CRI	80CRI	80CRI	80CRI
Beam angle / Işın açısı	114°	114°	114°	114°	114°
Light Output / Işık çıkışı	Only Direct / Sadece Direkt				

## Operating technology of the Luminaires / Armatürlerin çalışma teknolojisi

System Output / Sistem Çıkışı	23W
Voltage Type / Voltaj Tipi	220-240VAC
AC nominal voltage max. / AC nominal voltaj maks.	264VAC
Frequenz max. / Frekans maks.	63Hz
Lamp / Lamba	LED
Protection class / Koruma sınıfı	IP40
Degree of protection / Koruma derecesi	Class I
Control / Kontrol	ON - OFF / DALI / CASAMBI / TUNABLE WHITE
Rated Life time L80/B10 at 25°C	>50000 hrs

# Panos Radius Surface

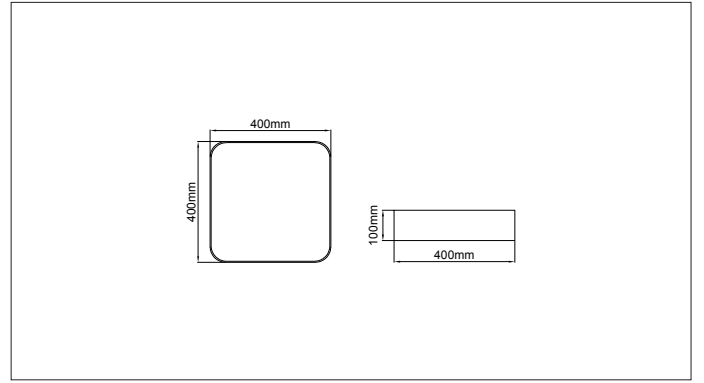

\* Code example / Kod örneği:

102.LL.25210.023.830.01

- 1- Product code / Armatür kodu
- 2- Power / Güç
- 3- CRI / Kelvin
- 4- Colour / Ürün renk
- 5- Control type / Kontrol tipi

4 / Product Color / Ürün Renk



Beam Angle / Işık Açısı

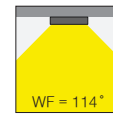

Wadge

Takoz



## Description / Tanım

Aluminium body. Opal or microprismatic diffuser options available. Mains voltage: 220-240V / 50-60Hz. 1-10V, DALI, Casambi DIM, Tunable White DALI, Tunable White CASAMBI, options available. Emergency kit system can be integrated. Basic colours: white, black, silver, antracite dark gray and special color options available upon request.

Alüminyum gövde. Opal veya mikroprizmatik difüzör seçenekleri mevcuttur. Şebeke gerilimi: 220-240V / 50-60Hz. 1-10V, DALI, Casambi DIM, Dinamik Beyaz DALI, Dinamik Beyaz CASAMBI seçenekleri mevcuttur. Acil durum kiti sistemi entegre edilebilir. Temel renkler: beyaz, siyah, gümüş, antrasit koyu gri ve istek üzerine özel renk seçenekleri mevcuttur.

## Product Data / Ürün Bilgileri

Article Nr. (AVOLUX)	102.LL.25210.(Power).(CRI).(Colour)
Material / Malzeme	Aluminium
Outer Diameter / Dış Çap	40x40cm
Height / Yükseklik	100mm
Weight / Ağırlık	2.5kg
Mouting method / Montaj yöntemi	Surface Mounted / Sıvaüstü

## Lighting Technology / Aydınlatma Teknolojisi

Colour Temperature / Renk Sıcaklığı	2700K	3000K	3500K	4000K	5000K
Luminous flux / Işık akısı	2593lm	2676lm	2717lm	2821lm	2862lm
System efficiency / Sistem verimliliği	113lm/W	116lm/W	118lm/W	123lm/W	124lm/W
Colour rendering / Renk oluşturma	80CRI	80CRI	80CRI	80CRI	80CRI
Beam angle / Işın açısı	114°	114°	114°	114°	114°
Light Output / Işık çıkışı	Only Direct / Sadece Direkt				

## Operating technology of the Luminaires / Armatürlerin çalışma teknolojisi

System Output / Sistem Çıkışı	23W
Voltage Type / Voltaj Tipi	220-240VAC
AC nominal voltage max. / AC nominal voltaj maks.	264VAC
Frequenz max. / Frekans maks.	63Hz
Lamp / Lamba	LED
Protection class / Koruma sınıfı	IP40
Degree of protection / Koruma derecesi	Class I
Control / Kontrol	ON - OFF / DALI / CASAMBI / TUNABLE WHITE
Rated Life time L80/B10 at 25°C	>50000 hrs

# Panos Radius Suspending

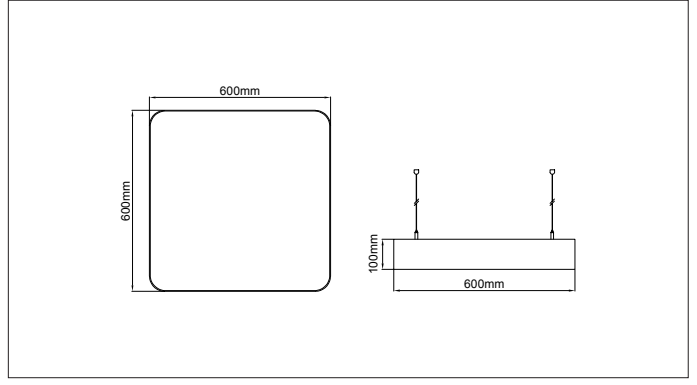

\* Code example / Kod örneği:

102.LL.26110.053.830.01

- 1- Product code / Armatür kodu
- 2- Power / Güç
- 3- CRI / Kelvin
- 4- Colour / Ürün renk
- 5- Control type / Kontrol tipi

4 / Product Color / Ürün Renk



Beam Angle / Işık Açısı

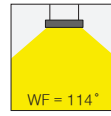

Suspension Wire

Sarkıtma Teli



## Description / Tanım

Aluminium body. Opal or microprismatic diffuser options available. Mains voltage: 220-240V / 50-60Hz. 1-10V, DALI, Casambi DIM, Tunable White DALI, Tunable White CASAMBI, options available. Emergency kit system can be integrated. Basic colours: white, black, silver, antracite dark gray and special color options available upon request. Steel suspension wire with up to 5mt lenght option together with standart or central baldachine.

Alüminyum gövde. Opal veya mikroprizmatik difüzör seçenekleri mevcuttur. Şebeke gerilimi: 220-240V / 50-60Hz. 1-10V, DALI, Casambi DIM, Dinamik Beyaz DALI, Dinamik Beyaz CASAMBI seçenekleri mevcuttur. Acil durum kiti sistemi entegre edilebilir. Temel renkler: beyaz, siyah, gümüş, antrasit koyu gri ve istek üzerine özel renk seçenekleri mevcuttur. Standart veya merkezi baldachine ile birlikte 5mt'ye kadar uzunluk seçeneği ile çelik asma teli.

## Product Data / Ürün Bilgileri

Article Nr. (AVOLUX)	102.LL.26110.(Power).(CRI).(Colour)
Material / Malzeme	Aluminium
Outer Diameter / Dış Çap	60x60cm
Height / Yükseklik	100mm
Weight / Ağırlık	4.5kg
Mouting method / Montaj yöntemi	Suspending / Sarkıt

## Lighting Technology / Aydınlatma Teknolojisi

Colour Temperature / Renk Sıcaklığı	2700K	3000K	3500K	4000K	5000K
Luminous flux / Işık akısı	6553lm	6763lm	6868lm	7130lm	7235lm
System efficiency / Sistem verimliliği	124lm/W	128lm/W	130lm/W	135lm/W	137lm/W
Colour rendering / Renk oluşturma	80CRI	80CRI	80CRI	80CRI	80CRI
Beam angle / Işın açısı	114°	114°	114°	114°	114°
Light Output / Işık çıkışı	Only Direct / Sadece Direkt				

## Operating technology of the Luminaires / Armatürlerin çalışma teknolojisi

System Output / Sistem Çıkışı	53W
Voltage Type / Voltaj Tipi	220-240VAC
AC nominal voltage max. / AC nominal voltaj maks.	264VAC
Frequenz max. / Frekans maks.	63Hz
Lamp / Lamba	LED
Protection class / Koruma sınıfı	IP40
Degree of protection / Koruma derecesi	Class I
Control / Kontrol	ON - OFF / DALI / CASAMBI / TUNABLE WHITE
Rated Life time L80/B10 at 25°C	>50000 hrs

# Panos Radius Surface

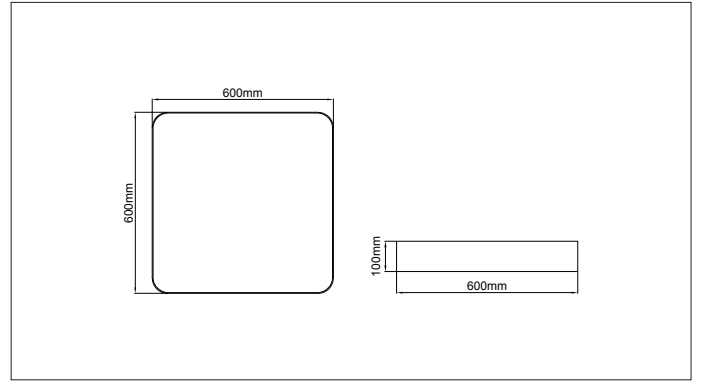
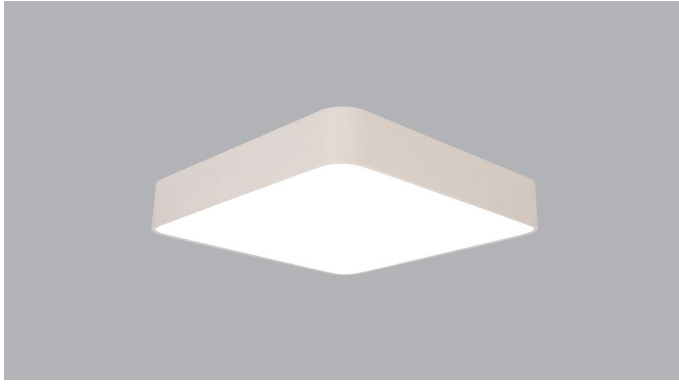

\* Code example / Kod örneği:

102.LL.26210.053.830.01

- 1- Product code / Armatür kodu
- 2- Power / Güç
- 3- CRI / Kelvin
- 4- Colour / Ürün renk
- 5- Control type / Kontrol tipi

#### 4 / Product Color / Ürün Renk

WHITE = 01	Ral 9010 = 02	BLACK = 03
GRAY = 04	DARK GRAY = 05	SPECIAL COLOR = 06

#### Beam Angle / Işık Açısı

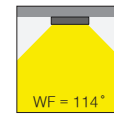

Wadge

Takoz



#### Description / Tanım

Aluminium body. Opal or microprismatic diffuser options available. Mains voltage: 220-240V / 50-60Hz. 1-10V, DALI, Casambi DIM, Tunable White DALI, Tunable White CASAMBI, options available. Emergency kit system can be integrated. Basic colours: white, black, silver, antracite dark gray and special color options available upon request.

Alüminyum gövde. Opal veya mikroprizmatik difüzör seçenekleri mevcuttur. Şebeke gerilimi: 220-240V / 50-60Hz. 1-10V, DALI, Casambi DIM, Dinamik Beyaz DALI, Dinamik Beyaz CASAMBI seçenekleri mevcuttur. Acil durum kiti sistemi entegre edilebilir. Temel renkler: beyaz, siyah, gümüş, antrasit koyu gri ve istek üzerine özel renk seçenekleri mevcuttur.

#### Product Data / Ürün Bilgileri

Article Nr. (AVOLUX)	102.LL.26210.(Power).(CRI).(Colour)
Material / Malzeme	Aluminium
Outer Diameter / Dış Çap	60x60cm
Height / Yükseklik	100mm
Weight / Ağırlık	4.5kg
Mouting method / Montaj yöntemi	Surface Mounted / Sıvaüstü

#### Lighting Technology / Aydınlatma Teknolojisi

Colour Temperature / Renk Sıcaklığı	2700K	3000K	3500K	4000K	5000K
Luminous flux / Işık akısı	6553lm	6763lm	6868lm	7130lm	7235lm
System efficiency / Sistem verimliliği	124lm/W	128lm/W	130lm/W	135lm/W	137lm/W
Colour rendering / Renk oluşturma	80CRI	80CRI	80CRI	80CRI	80CRI
Beam angle / Işın açısı	114°	114°	114°	114°	114°
Light Output / Işık çıkışı	Only Direct / Sadece Direkt				

#### Operating technology of the Luminaires / Armatürlerin çalışma teknolojisi

System Output / Sistem Çıkışı	53W
Voltage Type / Voltaj Tipi	220-240VAC
AC nominal voltage max. / AC nominal voltaj maks.	264VAC
Frequenz max. / Frekans maks.	63Hz
Lamp / Lamba	LED
Protection class / Koruma sınıfı	IP40
Degree of protection / Koruma derecesi	Class I
Control / Kontrol	ON - OFF / DALI / CASAMBI / TUNABLE WHITE
Rated Life time L80/B10 at 25°C	>50000 hrs



# Panos Radius Suspending

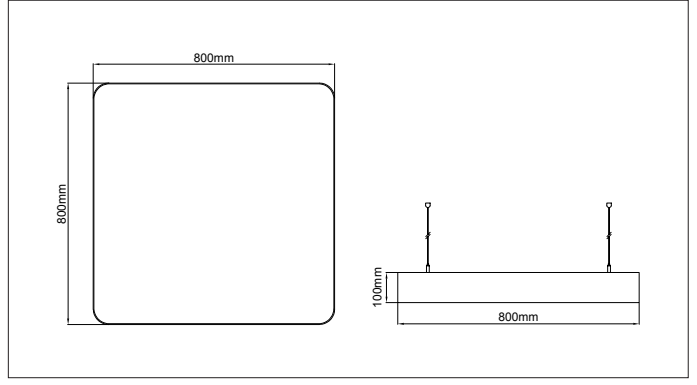

\* Code example / Kod örneği:

102.LL.27110.104.830.01

- 1- Product code / Armatür kodu
- 2- Power / Güç
- 3- CRI / Kelvin
- 4- Colour / Ürün renk
- 5- Control type / Kontrol tipi

4 / Product Color / Ürün Renk



Beam Angle / Işık Açısı

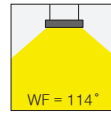

Suspension Wire

Sarkıtma Teli



## Description / Tanım

Aluminium body. Opal or microprismatic diffuser options available. Mains voltage: 220-240V / 50-60Hz. 1-10V, DALI, Casambi DIM, Tunable White DALI, Tunable White CASAMBI, options available. Emergency kit system can be integrated. Basic colours: white, black, silver, antracite dark gray and special color options available upon request. Steel suspension wire with up to 5mt lenght option together with standart or central baldachine.

Alüminyum gövde. Opal veya mikroprizmatik difüzör seçenekleri mevcuttur. Şebeke gerilimi: 220-240V / 50-60Hz. 1-10V, DALI, Casambi DIM, Dinamik Beyaz DALI, Dinamik Beyaz CASAMBI seçenekleri mevcuttur. Acil durum kiti sistemi entegre edilebilir. Temel renkler: beyaz, siyah, gümüş, antrasit koyu gri ve istek üzerine özel renk seçenekleri mevcuttur. Standart veya merkezi baldachine ile birlikte 5mt'ye kadar uzunluk seçeneği ile çelik asma teli.

## Product Data / Ürün Bilgileri

Article Nr. (AVOLUX)	102.LL.27110.(Power).(CRI).(Colour)
Material / Malzeme	Aluminium
Outer Diameter / Dış Çap	80x80cm
Height / Yükseklik	100mm
Weight / Ağırlık	6.5kg
Mouting method / Montaj yöntemi	Suspending / Sarkıt

## Lighting Technology / Aydınlatma Teknolojisi

Colour Temperature / Renk Sıcaklığı	2700K	3000K	3500K	4000K	5000K
Luminous flux / Işık akısı	13500lm	13932lm	14148lm	14687lm	14904lm
System efficiency / Sistem verimliliği	130lm/W	134lm/W	136lm/W	141lm/W	143lm/W
Colour rendering / Renk oluşturma	80CRI	80CRI	80CRI	80CRI	80CRI
Beam angle / Işın açısı	114°	114°	114°	114°	114°
Light Output / Işık çıkışı	Only Direct / Sadece Direkt				

## Operating technology of the Luminaires / Armatürlerin çalışma teknolojisi

System Output / Sistem Çıkışı	104W
Voltage Type / Voltaj Tipi	220-240VAC
AC nominal voltage max. / AC nominal voltaj maks.	264VAC
Frequenz max. / Frekans maks.	63Hz
Lamp / Lamba	LED
Protection class / Koruma sınıfı	IP40
Degree of protection / Koruma derecesi	Class I
Control / Kontrol	ON - OFF / DALI / CASAMBI / TUNABLE WHITE
Rated Life time L80/B10 at 25°C	>50000 hrs

# Panos Radius Surface

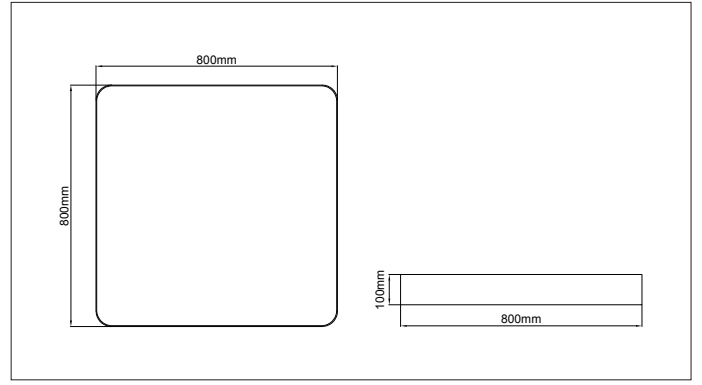
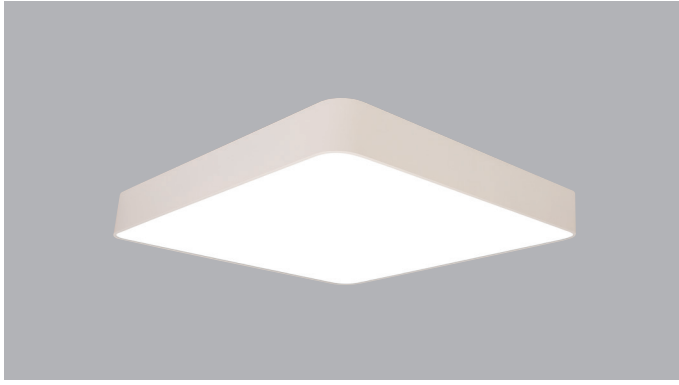

\* Code example / Kod örneği:

102.LL.27210. 104 . 830 . 01

- 1- Product code / Armatür kodu
- 2- Power / Güç
- 3- CRI / Kelvin
- 4- Colour / Ürün renk
- 5- Control type / Kontrol tipi

#### 4 / Product Color / Ürün Renk

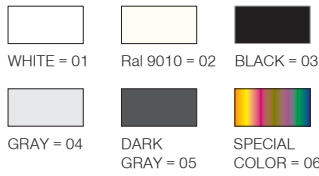

#### Beam Angle / Işık Açısı

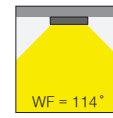

Wadge

Takoz



#### Description / Tanım

Aluminium body. Opal or microprismatic diffuser options available. Mains voltage: 220-240V / 50-60Hz. 1-10V, DALI, Casambi DIM, Tunable White DALI, Tunable White CASAMBI, options available. Emergency kit system can be integrated. Basic colours: white, black, silver, antracite dark gray and special color options available upon request.

Alüminyum gövde. Opal veya mikroprizmatik difüzör seçenekleri mevcuttur. Şebeke gerilimi: 220-240V / 50-60Hz. 1-10V, DALI, Casambi DIM, Dinamik Beyaz DALI, Dinamik Beyaz CASAMBI seçenekleri mevcuttur. Acil durum kiti sistemi entegre edilebilir. Temel renkler: beyaz, siyah, gümüş, antrasit koyu gri ve istek üzerine özel renk seçenekleri mevcuttur.

#### Product Data / Ürün Bilgileri

Article Nr. (AVOLUX)	102.LL.27210.(Power).(CRI).(Colour)
Material / Malzeme	Aluminium
Outer Diameter / Dış Çap	80x80cm
Height / Yükseklik	100mm
Weight / Ağırlık	6.5kg
Mouting method / Montaj yöntemi	Surface Mounted / Sıvaüstü

#### Lighting Technology / Aydınlatma Teknolojisi

Colour Temperature / Renk Sıcaklığı	2700K	3000K	3500K	4000K	5000K
Luminous flux / Işık akısı	13500lm	13932lm	14148lm	14687lm	14904lm
System efficiency / Sistem verimliliği	130lm/W	134lm/W	136lm/W	141lm/W	143lm/W
Colour rendering / Renk oluşturma	80CRI	80CRI	80CRI	80CRI	80CRI
Beam angle / Işın açısı	114°	114°	114°	114°	114°
Light Output / Işık çıkışı	Only Direct / Sadece Direkt				

#### Operating technology of the Luminaires / Armatürlerin çalışma teknolojisi

System Output / Sistem Çıkışı	104W
Voltage Type / Voltaj Tipi	220-240VAC
AC nominal voltage max. / AC nominal voltaj maks.	264VAC
Frequenz max. / Frekans maks.	63Hz
Lamp / Lamba	LED
Protection class / Koruma sınıfı	IP40
Degree of protection / Koruma derecesi	Class I
Control / Kontrol	ON - OFF / DALI / CASAMBI / TUNABLE WHITE
Rated Life time L80/B10 at 25°C	>50000 hrs

# Panos Radius Direct/Indirect

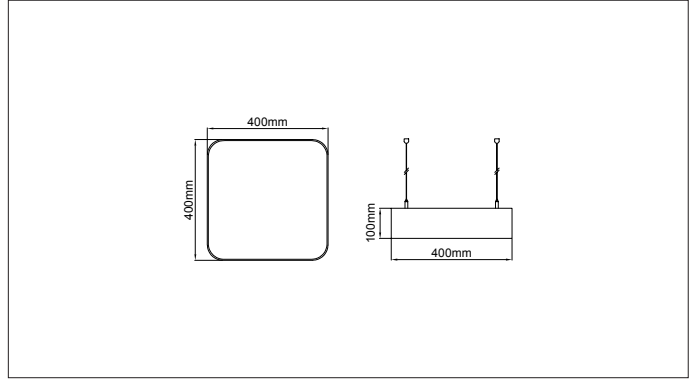

\* Code example / Kod örneği:

102.LL.25310.034.830.01

- 1- Product code / Armatür kodu
- 2- Power / Güç
- 3- CRI / Kelvin
- 4- Colour / Ürün renk
- 5- Control type / Kontrol tipi

4 / Product Color / Ürün Renk



Beam Angle / Işık Açısı

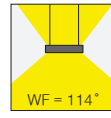

Suspension Wire

Sarkıtma Teli



## Description / Tanım

Aluminium body. Opal or microprismatic diffuser options available. Mains voltage: 220-240V / 50-60Hz. 1-10V, DALI, Casambi DIM, Tunable White DALI, Tunable White CASAMBI, options available. Emergency kit system can be integrated. Basic colours: white, black, silver, antracite dark gray and special color options available upon request. Steel suspension wire with up to 5mt lenght option together with standart or central baldachine.

Alüminyum gövde. Opal veya mikroprizmatik difüzör seçenekleri mevcuttur. Şebeke gerilimi: 220-240V / 50-60Hz. 1-10V, DALI, Casambi DIM, Dinamik Beyaz DALI, Dinamik Beyaz CASAMBI seçenekleri mevcuttur. Acil durum kiti sistemi entegre edilebilir. Temel renkler: beyaz, siyah, gümüş, antrasit koyu gri ve istek üzerine özel renk seçenekleri mevcuttur. Standart veya merkezi baldachine ile birlikte 5mt'ye kadar uzunluk seçeneği ile çelik asma teli.

## Product Data / Ürün Bilgileri

Article Nr. (AVOLUX)	102.LL.25310.(Power).(CRI).(Colour)
Material / Malzeme	Aluminium
Outer Diameter / Dış Çap	40x40cm
Height / Yükseklik	100mm
Weight / Ağırlık	2.5kg
Mouting method / Montaj yöntemi	Suspendant / Sarkıt

## Lighting Technology / Aydınlatma Teknolojisi

Colour Temperature / Renk Sıcaklığı	2700K	3000K	3500K	4000K	5000K
Total Luminous flux / Toplam Işık akısı	3170lm	3271lm	3321lm	3449lm	3499lm
System efficiency / Sistem verimliliği	93lm/W	96lm/W	98lm/W	101lm/W	103lm/W
Luminous flux Direct / Işık akısı Direkt	2593lm	2676lm	2717lm	2821lm	2862lm
Luminous flux Indirect / Işık akısı Endirekt	577lm	595lm	604lm	628lm	637lm
Colour rendering / Renk oluşturma	80CRI	80CRI	80CRI	80CRI	80CRI
Beam angle / Işın açısı	114°	114°	114°	114°	114°
Light Output / Işık çıkışı	Direct - Indirect / Direkt - Endirekt				

## Operating technology of the Luminaires / Armatürlerin çalışma teknolojisi

System Output / Sistem Çıkışı	34W (23W Direkt - 11W İndirect)
Voltage Type / Voltaj Tipi	220-240VAC
AC nominal voltage max. / AC nominal voltaj maks.	264VAC
Frequenz max. / Frekans maks.	63Hz
Lamp / Lamba	LED
Protection class / Koruma sınıfı	IP40
Degree of protection / Koruma derecesi	Class I
Control / Kontrol	ON - OFF / DALI / CASAMBI / TUNABLE WHITE
Rated Life time L80/B10 at 25°C	>50000 hrs

# Panos Radius Direct/Indirect

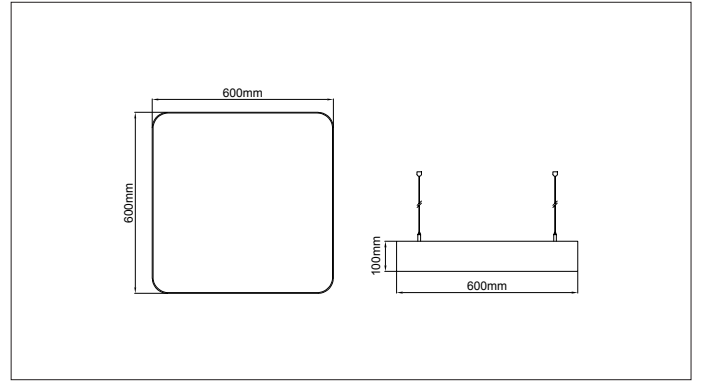
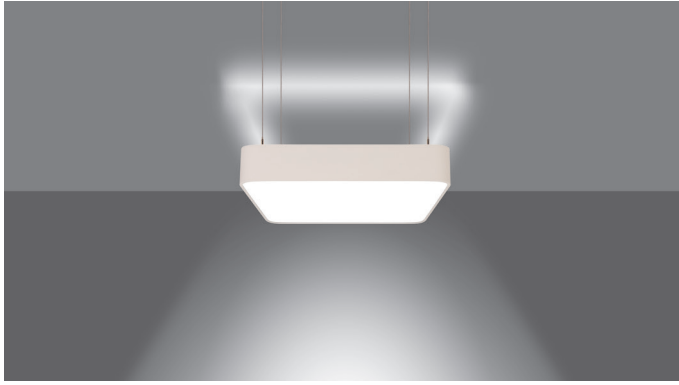

\* Code example / Kod örneği:

102.LL.26310.077.830.01

- 1- Product code / Armatür kodu
- 2- Power / Güç
- 3- CRI / Kelvin
- 4- Colour / Ürün renk
- 5- Control type / Kontrol tipi

#### 4 / Product Color / Ürün Renk



#### Beam Angle / Işık Açısı

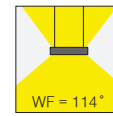

Suspension Wire  
Sarkıtma Teli



#### Description / Tanım

Aluminium body. Opal or microprismatic diffuser options available. Mains voltage: 220-240V / 50-60Hz. 1-10V, DALI, Casambi DIM, Tunable White DALI, Tunable White CASAMBI, options available. Emergency kit system can be integrated. Basic colours: white, black, silver, antracite dark gray and special color options available upon request. Steel suspension wire with up to 5mt length option together with standart or central baldachine.

Alüminyum gövde. Opal veya mikroprizmatik difüzör seçenekleri mevcuttur. Şebeke gerilimi: 220-240V / 50-60Hz. 1-10V, DALI, Casambi DIM, Dinamik Beyaz DALI, Dinamik Beyaz CASAMBI seçenekleri mevcuttur. Acil durum kiti sistemi entegre edilebilir. Temel renkler: beyaz, siyah, gümüş, antrasit koyu gri ve istek üzerine özel renk seçenekleri mevcuttur. Standart veya merkezi baldachine ile birlikte 5mt'ye kadar uzunluk seçeneği ile çelik asma teli.

#### Product Data / Ürün Bilgileri

Article Nr. (AVOLUX)	102.LL.26310.(Power).(CRI).(Colour)
Material / Malzeme	Aluminium
Outer Diameter / Dış Çap	60x60cm
Height / Yükseklik	100mm
Weight / Ağırlık	4.5kg
Mouting method / Montaj yöntemi	Suspendant / Sarkıt

#### Lighting Technology / Aydınlatma Teknolojisi

Colour Temperature / Renk Sıcaklığı	2700K	3000K	3500K	4000K	5000K
Total Luminous flux / Toplam Işık akısı	8054lm	8312lm	8441lm	8763lm	8892lm
System efficiency / Sistem verimliliği	105lm/W	108lm/W	110lm/W	114lm/W	115lm/W
Luminous flux Direct / Işık akısı Direkt	6553lm	6763lm	6868lm	7130lm	7235lm
Luminous flux Indirect / Işık akısı Endirekt	1501lm	1549lm	1573lm	1633lm	1657lm
Colour rendering / Renk oluşturma	80CRI	80CRI	80CRI	80CRI	80CRI
Beam angle / Işın açısı	114°	114°	114°	114°	114°
Light Output / Işık çıkışı	Direct - Indirect / Direkt - Endirekt				

#### Operating technology of the Luminaires / Armatürlerin çalışma teknolojisi

System Output / Sistem Çıkışı	77W (53W Direkt - 24W Indirect)
Voltage Type / Voltaj Tipi	220-240VAC
AC nominal voltage max. / AC nominal voltaj maks.	264VAC
Frequenz max. / Frekans maks.	63Hz
Lamp / Lamba	LED
Protection class / Koruma sınıfı	IP40
Degree of protection / Koruma derecesi	Class I
Control / Kontrol	ON - OFF / DALI / CASAMBI / TUNABLE WHITE
Rated Life time L80/B10 at 25°C	>50000 hrs

# Panos Radius Direct/Indirect

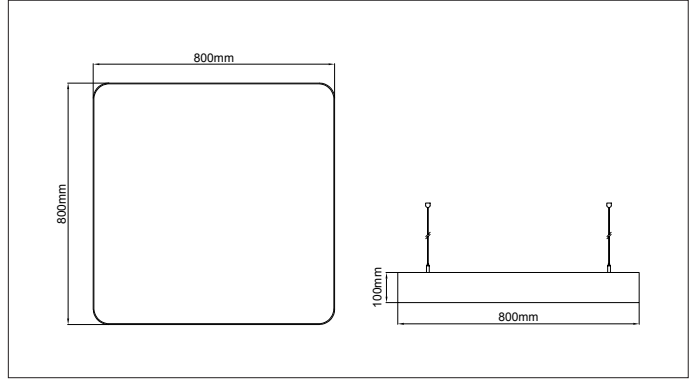

\* Code example / Kod örneği:

102.LL.27310.130.830.01  
1 2 3 4

- 1- Product code / Armatür kodu
- 2- Power / Güç
- 3- CRI / Kelvin
- 4- Colour / Ürün renk
- 5- Control type / Kontrol tipi

4 / Product Color / Ürün Renk



Beam Angle / Işık Açısı

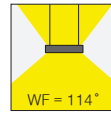

Suspension Wire

Sarkıtma Teli



## Description / Tanım

Aluminium body. Opal or microprismatic diffuser options available. Mains voltage: 220-240V / 50-60Hz. 1-10V, DALI, Casambi DIM, Tunable White DALI, Tunable White CASAMBI, options available. Emergency kit system can be integrated. Basic colours: white, black, silver, antracite dark gray and special color options available upon request. Steel suspension wire with up to 5mt lenght option together with standart or central baldachine.

Alüminyum gövde. Opal veya mikroprizmatik difüzör seçenekleri mevcuttur. Şebeke gerilimi: 220-240V / 50-60Hz. 1-10V, DALI, Casambi DIM, Dinamik Beyaz DALI, Dinamik Beyaz CASAMBI seçenekleri mevcuttur. Acil durum kiti sistemi entegre edilebilir. Temel renkler: beyaz, siyah, gümüş, antrasit koyu gri ve istek üzerine özel renk seçenekleri mevcuttur. Standart veya merkezi baldachine ile birlikte 5mt'ye kadar uzunluk seçeneği ile çelik asma teli.

## Product Data / Ürün Bilgileri

Article Nr. (AVOLUX)	102.LL.27310.(Power).(CRI).(Colour)
Material / Malzeme	Aluminium
Outer Diameter / Dış Çap	80x80cm
Height / Yükseklik	100mm
Weight / Ağırlık	6.5kg
Mouting method / Montaj yöntemi	Suspendant / Sarkıt

## Lighting Technology / Aydınlatma Teknolojisi

Colour Temperature / Renk Sıcaklığı	2700K	3000K	3500K	4000K	5000K
Total Luminous flux / Toplam Işık akısı	15058lm	15540lm	15781lm	16383lm	16625lm
System efficiency / Sistem verimliliği	116lm/W	120lm/W	122lm/W	127lm/W	128lm/W
Luminous flux Direct / Işık akısı Direkt	13500lm	13932lm	14148lm	14687lm	14904lm
Luminous flux Indirect / Işık akısı Endirekt	1558lm	1608lm	1633lm	1696lm	1721lm
Colour rendering / Renk oluşturma	80CRI	80CRI	80CRI	80CRI	80CRI
Beam angle / Işın açısı	114°	114°	114°	114°	114°
Light Output / Işık çıkışı	Direct - Indirect / Direkt - Endirekt				

## Operating technology of the Luminaires / Armatürlerin çalışma teknolojisi

System Output / Sistem Çıkışı	129.5W (104W Direkt - 25.5W İndirect)
Voltage Type / Voltaj Tipi	220-240VAC
AC nominal voltage max. / AC nominal voltaj maks.	264VAC
Frequenz max. / Frekans maks.	63Hz
Lamp / Lamba	LED
Protection class / Koruma sınıfı	IP40
Degree of protection / Koruma derecesi	Class I
Control / Kontrol	ON - OFF / DALI / CASAMBI / TUNABLE WHITE
Rated Life time L80/B10 at 25°C	>50000 hrs

# LDT Files / LDT Dataları

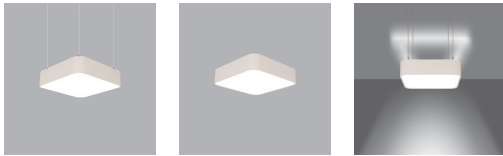

I02.LL.25110

I02.LL.25210

I02.LL.25310

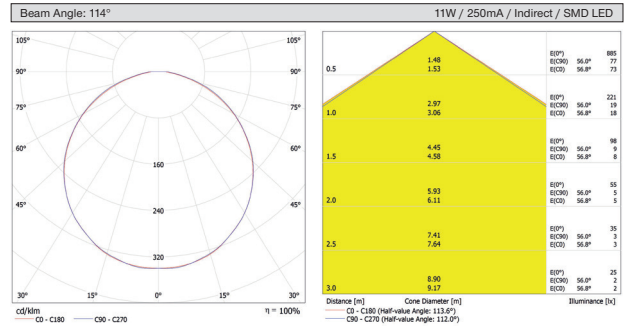
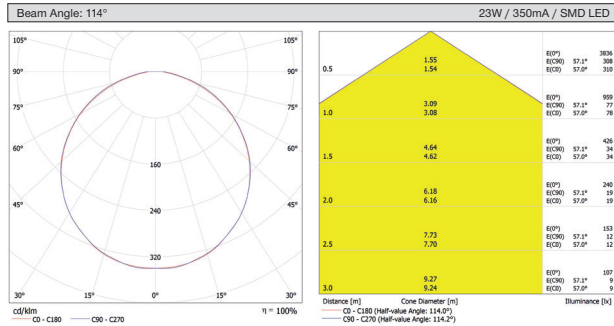

I02.LL.26110

I02.LL.26210

I02.LL.26310

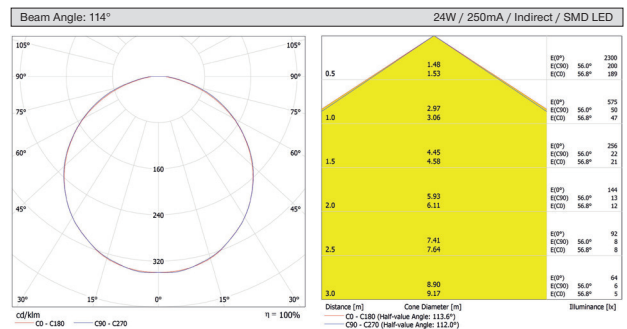
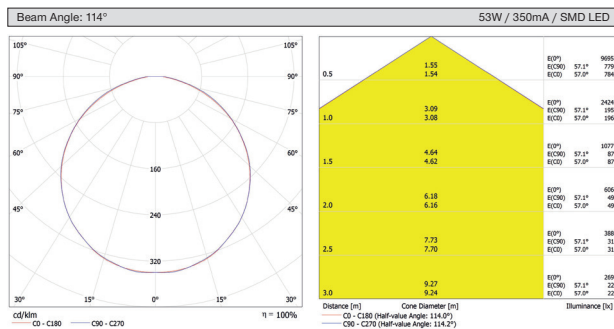

I02.LL.27110

I02.LL.27210

I02.LL.27310

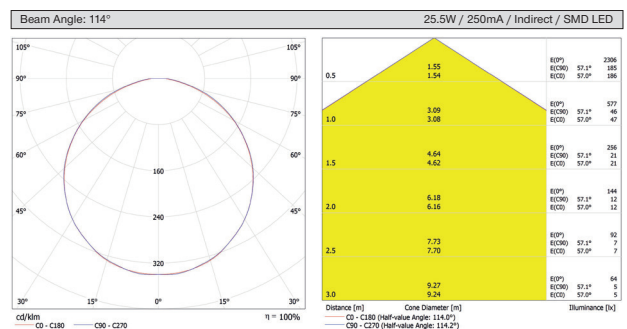
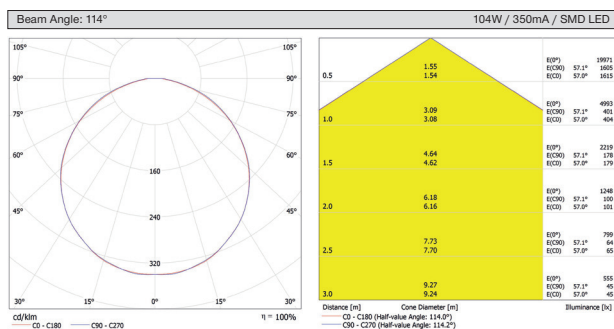

Linea Led Series / Linea Led Serisi

# Panos Radius Slim Suspendant

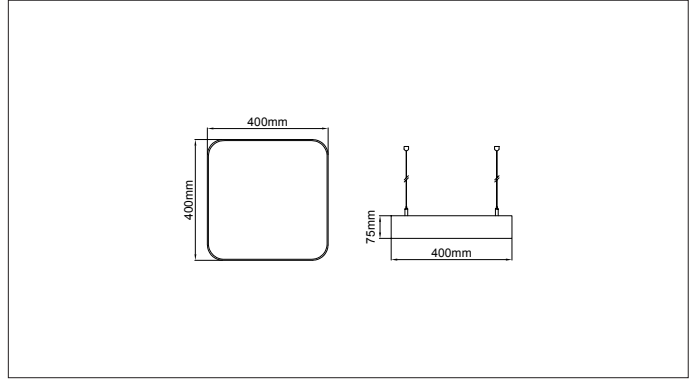

\* Code example / Kod örneği:

102.LL.25107 . 023 . 830 . 01

- 1- Product code / Armatür kodu
- 2- Power / Güç
- 3- CRI / Kelvin
- 4- Colour / Ürün renk
- 5- Control type / Kontrol tipi

4 / Product Color / Ürün Renk



Beam Angle / Işık Açısı

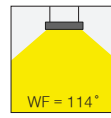

Suspension Wire

Sarkıtma Teli



## Description / Tanım

Aluminium body. Opal or microprismatic diffuser options available. Mains voltage: 220-240V / 50-60Hz. 1-10V, DALI, Casambi DIM, Tunable White DALI, Tunable White CASAMBI, options available. Emergency kit system can be integrated. Basic colours: white, black, silver, antracite dark gray and special color options available upon request. Steel suspension wire with up to 5mt lenght option together with standart or central baldachine.

Alüminyum gövde. Opal veya mikroprizmatik difüzör seçenekleri mevcuttur. Şebeke gerilimi: 220-240V / 50-60Hz. 1-10V, DALI, Casambi DIM, Dinamik Beyaz DALI, Dinamik Beyaz CASAMBI seçenekleri mevcuttur. Acil durum kiti sistemi entegre edilebilir. Temel renkler: beyaz, siyah, gümüş, antrasit koyu gri ve istek üzerine özel renk seçenekleri mevcuttur. Standart veya merkezi baldachine ile birlikte 5mt'ye kadar uzunluk seçeneği ile çelik asma teli.

## Product Data / Ürün Bilgileri

Article Nr. (AVOLUX)	102.LL.25107.(Power).(CRI).(Colour)
Material / Malzeme	Aluminium
Outer Diameter / Dış Çap	40x40cm
Height / Yükseklik	75mm
Weight / Ağırlık	2.5kg
Mouting method / Montaj yöntemi	Suspendant / Sarkıt

## Lighting Technology / Aydınlatma Teknolojisi

Colour Temperature / Renk Sıcaklığı	2700K	3000K	3500K	4000K	5000K
Luminous flux / Işık akısı	2593lm	2676lm	2717lm	2821lm	2862lm
System efficiency / Sistem verimliliği	113lm/W	116lm/W	118lm/W	123lm/W	124lm/W
Colour rendering / Renk oluşturma	80CRI	80CRI	80CRI	80CRI	80CRI
Beam angle / Işın açısı	114°	114°	114°	114°	114°
Light Output / Işık çıkışı	Only Direct / Sadece Direkt				

## Operating technology of the Luminaires / Armatürlerin çalışma teknolojisi

System Output / Sistem Çıkışı	23W
Voltage Type / Voltaj Tipi	220-240VAC
AC nominal voltage max. / AC nominal voltaj maks.	264VAC
Frequenz max. / Frekans maks.	63Hz
Lamp / Lamba	LED
Protection class / Koruma sınıfı	IP40
Degree of protection / Koruma derecesi	Class I
Control / Kontrol	ON - OFF / DALI / CASAMBI / TUNABLE WHITE
Rated Life time L80/B10 at 25°C	>50000 hrs

# Panos Radius Slim Surface

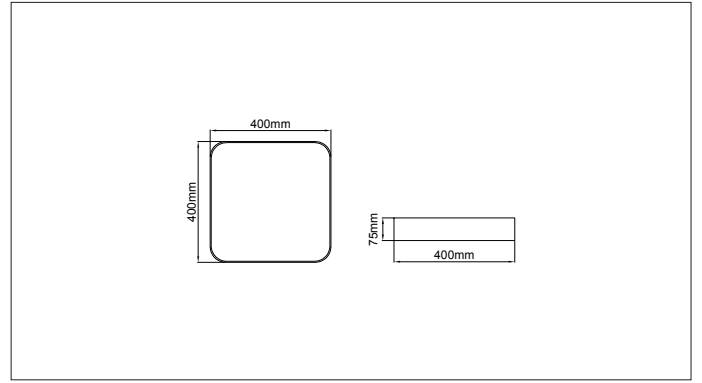

\* Code example / Kod örneği:

102.LL.25207 . 023 . 830 . 01

- 1- Product code / Armatür kodu
- 2- Power / Güç
- 3- CRI / Kelvin
- 4- Colour / Ürün renk
- 5- Control type / Kontrol tipi

4 / Product Color / Ürün Renk

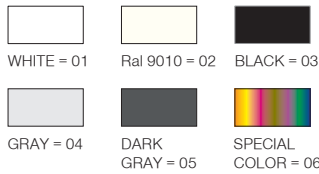

Beam Angle / Işık Açısı

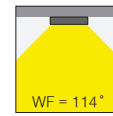

Wadge

Takoz



## Description / Tanım

Aluminium body. Opal or microprismatic diffuser options available. Mains voltage: 220-240V / 50-60Hz. 1-10V, DALI, Casambi DIM, Tunable White DALI, Tunable White CASAMBI, options available. Emergency kit system can be integrated. Basic colours: white, black, silver, antracite dark gray and special color options available upon request.

Alüminyum gövde. Opal veya mikroprizmatik difüzör seçenekleri mevcuttur. Şebeke gerilimi: 220-240V / 50-60Hz. 1-10V, DALI, Casambi DIM, Dinamik Beyaz DALI, Dinamik Beyaz CASAMBI seçenekleri mevcuttur. Acil durum kiti sistemi entegre edilebilir. Temel renkler: beyaz, siyah, gümüş, antrasit koyu gri ve istek üzerine özel renk seçenekleri mevcuttur.

## Product Data / Ürün Bilgileri

Article Nr. (AVOLUX)	102.LL.25207.(Power).(CRI).(Colour)
Material / Malzeme	Aluminium
Outer Diameter / Dış Çap	40x40cm
Height / Yükseklik	75mm
Weight / Ağırlık	2.5kg
Mouting method / Montaj yöntemi	Surface Mounted / Sıvaüstü

## Lighting Technology / Aydınlatma Teknolojisi

Colour Temperature / Renk Sıcaklığı	2700K	3000K	3500K	4000K	5000K
Luminous flux / Işık akısı	2593lm	2676lm	2717lm	2821lm	2862lm
System efficiency / Sistem verimliliği	113lm/W	116lm/W	118lm/W	123lm/W	124lm/W
Colour rendering / Renk oluşturma	80CRI	80CRI	80CRI	80CRI	80CRI
Beam angle / Işın açısı	114°	114°	114°	114°	114°
Light Output / Işık çıkışı	Only Direct / Sadece Direkt				

## Operating technology of the Luminaires / Armatürlerin çalışma teknolojisi

System Output / Sistem Çıkışı	23W
Voltage Type / Voltaj Tipi	220-240VAC
AC nominal voltage max. / AC nominal voltaj maks.	264VAC
Frequenz max. / Frekans maks.	63Hz
Lamp / Lamba	LED
Protection class / Koruma sınıfı	IP40
Degree of protection / Koruma derecesi	Class I
Control / Kontrol	ON - OFF / DALI / CASAMBI / TUNABLE WHITE
Rated Life time L80/B10 at 25°C	>50000 hrs



# Panos Radius Slim Suspendant

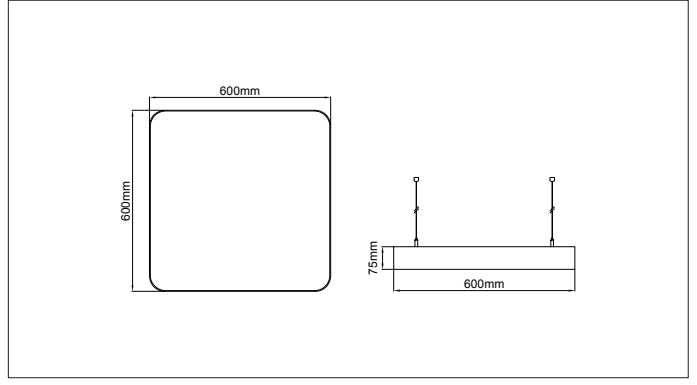

\* Code example / Kod örneği:

102.LL.26107.053.830.01

- 1- Product code / Armatür kodu
- 2- Power / Güç
- 3- CRI / Kelvin
- 4- Colour / Ürün renk
- 5- Control type / Kontrol tipi

4 / Product Color / Ürün Renk



Beam Angle / Işık Açısı

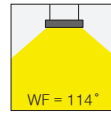

Suspension Wire

Sarkıtma Teli



## Description / Tanım

Aluminium body. Opal or microprismatic diffuser options available. Mains voltage: 220-240V / 50-60Hz. 1-10V, DALI, Casambi DIM, Tunable White DALI, Tunable White CASAMBI, options available. Emergency kit system can be integrated. Basic colours: white, black, silver, antracite dark gray and special color options available upon request. Steel suspension wire with up to 5mt lenght option together with standart or central baldachine.

Alüminyum gövde. Opal veya mikroprizmatik difüzör seçenekleri mevcuttur. Şebeke gerilimi: 220-240V / 50-60Hz. 1-10V, DALI, Casambi DIM, Dinamik Beyaz DALI, Dinamik Beyaz CASAMBI seçenekleri mevcuttur. Acil durum kiti sistemi entegre edilebilir. Temel renkler: beyaz, siyah, gümüş, antrasit koyu gri ve istek üzerine özel renk seçenekleri mevcuttur. Standart veya merkezi baldachine ile birlikte 5mt'ye kadar uzunluk seçeneği ile çelik asma teli.

## Product Data / Ürün Bilgileri

Article Nr. (AVOLUX)	102.LL.26107.(Power).(CRI).(Colour)
Material / Malzeme	Aluminium
Outer Diameter / Dış Çap	60x60cm
Height / Yükseklik	75mm
Weight / Ağırlık	4.5kg
Mouting method / Montaj yöntemi	Suspendant / Sarkıt

## Lighting Technology / Aydınlatma Teknolojisi

Colour Temperature / Renk Sıcaklığı	2700K	3000K	3500K	4000K	5000K
Luminous flux / Işık akısı	6553lm	6763lm	6868lm	7130lm	7235lm
System efficiency / Sistem verimliliği	124lm/W	128lm/W	130lm/W	135lm/W	137lm/W
Colour rendering / Renk oluşturma	80CRI	80CRI	80CRI	80CRI	80CRI
Beam angle / Işın açısı	114°	114°	114°	114°	114°
Light Output / Işık çıkışı	Only Direct / Sadece Direkt				

## Operating technology of the Luminaires / Armatürlerin çalışma teknolojisi

System Output / Sistem Çıkışı	53W
Voltage Type / Voltaj Tipi	220-240VAC
AC nominal voltage max. / AC nominal voltaj maks.	264VAC
Frequenz max. / Frekans maks.	63Hz
Lamp / Lamba	LED
Protection class / Koruma sınıfı	IP40
Degree of protection / Koruma derecesi	Class I
Control / Kontrol	ON - OFF / DALI / CASAMBI / TUNABLE WHITE
Rated Life time L80/B10 at 25°C	>50000 hrs

# Panos Radius Slim Surface

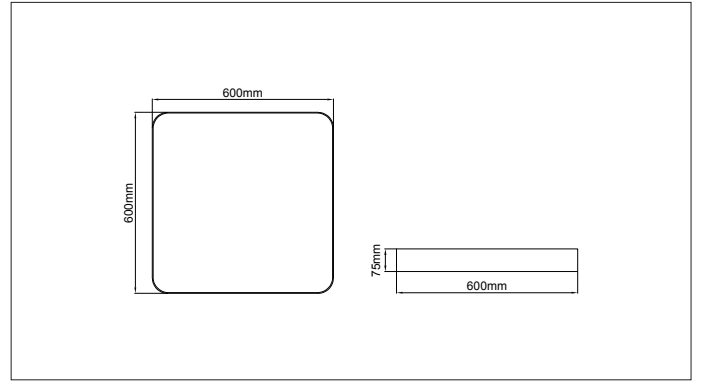
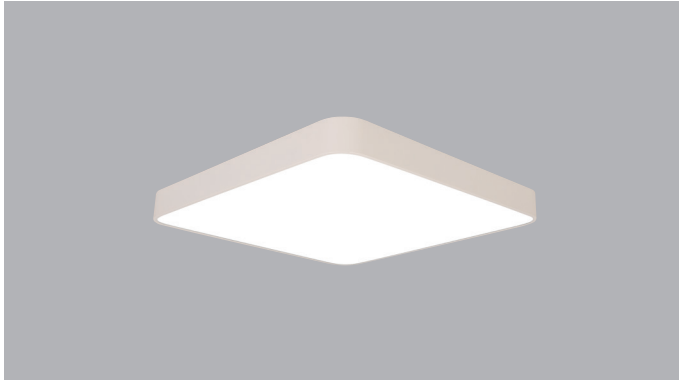

\* Code example / Kod örneği:

102.LL.26207 . 053 . 830 . 01

- 1- Product code / Armatür kodu
- 2- Power / Güç
- 3- CRI / Kelvin
- 4- Colour / Ürün renk
- 5- Control type / Kontrol tipi

#### 4 / Product Color / Ürün Renk

WHITE = 01	Ral 9010 = 02	BLACK = 03
GRAY = 04	DARK GRAY = 05	SPECIAL COLOR = 06

#### Beam Angle / Işık Açısı

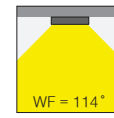

Wadge

Takoz



#### Description / Tanım

Aluminium body. Opal or microprismatic diffuser options available. Mains voltage: 220-240V / 50-60Hz. 1-10V, DALI, Casambi DIM, Tunable White DALI, Tunable White CASAMBI, options available. Emergency kit system can be integrated. Basic colours: white, black, silver, antracite dark gray and special color options available upon request.

Alüminyum gövde. Opal veya mikroprizmatik difüzör seçenekleri mevcuttur. Şebeke gerilimi: 220-240V / 50-60Hz. 1-10V, DALI, Casambi DIM, Dinamik Beyaz DALI, Dinamik Beyaz CASAMBI seçenekleri mevcuttur. Acil durum kiti sistemi entegre edilebilir. Temel renkler: beyaz, siyah, gümüş, antrasit koyu gri ve istek üzerine özel renk seçenekleri mevcuttur.

#### Product Data / Ürün Bilgileri

Article Nr. (AVOLUX)	102.LL.26207.(Power).(CRI).(Colour)
Material / Malzeme	Aluminium
Outer Diameter / Dış Çap	60x60cm
Height / Yükseklik	75mm
Weight / Ağırlık	4.5kg
Mouting method / Montaj yöntemi	Surface Mounted / Sıvaüstü

#### Lighting Technology / Aydınlatma Teknolojisi

Colour Temperature / Renk Sıcaklığı	2700K	3000K	3500K	4000K	5000K
Luminous flux / Işık akısı	6553lm	6763lm	6868lm	7130lm	7235lm
System efficiency / Sistem verimliliği	124lm/W	128lm/W	130lm/W	135lm/W	137lm/W
Colour rendering / Renk oluşturma	80CRI	80CRI	80CRI	80CRI	80CRI
Beam angle / Işın açısı	114°	114°	114°	114°	114°
Light Output / Işık çıkışı	Only Direct / Sadece Direkt				

#### Operating technology of the Luminaires / Armatürlerin çalışma teknolojisi

System Output / Sistem Çıkışı	53W
Voltage Type / Voltaj Tipi	220-240VAC
AC nominal voltage max. / AC nominal voltaj maks.	264VAC
Frequenz max. / Frekans maks.	63Hz
Lamp / Lamba	LED
Protection class / Koruma sınıfı	IP40
Degree of protection / Koruma derecesi	Class I
Control / Kontrol	ON - OFF / DALI / CASAMBI / TUNABLE WHITE
Rated Life time L80/B10 at 25°C	>50000 hrs

# Panos Radius Slim Suspendant

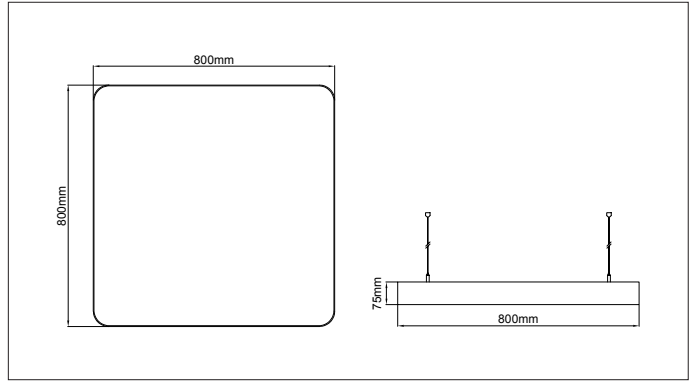

\* Code example / Kod örneği:

102.LL.27107 . 104 . 830 . 01

- 1- Product code / Armatür kodu
- 2- Power / Güç
- 3- CRI / Kelvin
- 4- Colour / Ürün renk
- 5- Control type / Kontrol tipi

4 / Product Color / Ürün Renk



Beam Angle / Işık Açısı

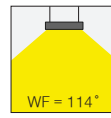

Suspension Wire

Sarkıtma Teli



## Description / Tanım

Aluminium body. Opal or microprismatic diffuser options available. Mains voltage: 220-240V / 50-60Hz. 1-10V, DALI, Casambi DIM, Tunable White DALI, Tunable White CASAMBI, options available. Emergency kit system can be integrated. Basic colours: white, black, silver, antracite dark gray and special color options available upon request. Steel suspension wire with up to 5mt lenght option together with standart or central baldachine.

Alüminyum gövde. Opal veya mikroprizmatik difüzör seçenekleri mevcuttur. Şebeke gerilimi: 220-240V / 50-60Hz. 1-10V, DALI, Casambi DIM, Dinamik Beyaz DALI, Dinamik Beyaz CASAMBI seçenekleri mevcuttur. Acil durum kiti sistemi entegre edilebilir. Temel renkler: beyaz, siyah, gümüş, antrasit koyu gri ve istek üzerine özel renk seçenekleri mevcuttur. Standart veya merkezi baldachine ile birlikte 5mt'ye kadar uzunluk seçeneği ile çelik asma teli.

## Product Data / Ürün Bilgileri

Article Nr. (AVOLUX)	102.LL.27107.(Power).(CRI).(Colour)
Material / Malzeme	Aluminium
Outer Diameter / Dış Çap	80x80cm
Height / Yükseklik	75mm
Weight / Ağırlık	6.5kg
Mouting method / Montaj yöntemi	Suspendant / Sarkıt

## Lighting Technology / Aydınlatma Teknolojisi

Colour Temperature / Renk Sıcaklığı	2700K	3000K	3500K	4000K	5000K
Luminous flux / Işık akısı	13500lm	13932lm	14148lm	14687lm	14904lm
System efficiency / Sistem verimliliği	130lm/W	134lm/W	136lm/W	141lm/W	143lm/W
Colour rendering / Renk oluşturma	80CRI	80CRI	80CRI	80CRI	80CRI
Beam angle / Işın açısı	114°	114°	114°	114°	114°
Light Output / Işık çıkışı	Only Direct / Sadece Direkt				

## Operating technology of the Luminaires / Armatürlerin çalışma teknolojisi

System Output / Sistem Çıkışı	104W
Voltage Type / Voltaj Tipi	220-240VAC
AC nominal voltage max. / AC nominal voltaj maks.	264VAC
Frequenz max. / Frekans maks.	63Hz
Lamp / Lamba	LED
Protection class / Koruma sınıfı	IP40
Degree of protection / Koruma derecesi	Class I
Control / Kontrol	ON - OFF / DALI / CASAMBI / TUNABLE WHITE
Rated Life time L80/B10 at 25°C	>50000 hrs

# Panos Radius Slim Surface

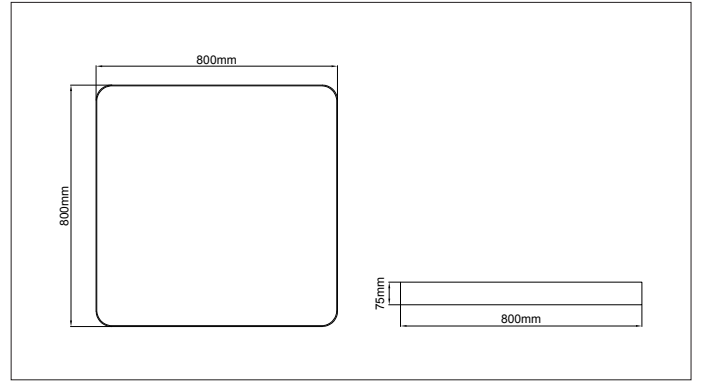
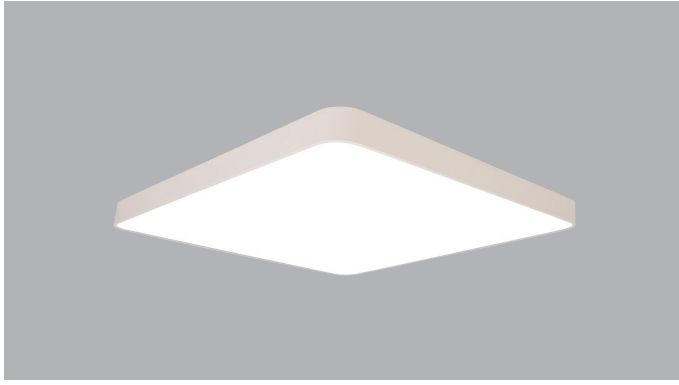

\* Code example / Kod örneği:

102.LL.27207 . 104 . 830 . 01

- 1- Product code / Armatür kodu
- 2- Power / Güç
- 3- CRI / Kelvin
- 4- Colour / Ürün renk
- 5- Control type / Kontrol tipi

4 / Product Color / Ürün Renk



Beam Angle / Işık Açısı

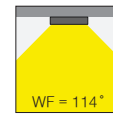

Wadge

Takoz



## Description / Tanım

Aluminium body. Opal or microprismatic diffuser options available. Mains voltage: 220-240V / 50-60Hz. 1-10V, DALI, Casambi DIM, Tunable White DALI, Tunable White CASAMBI, options available. Emergency kit system can be integrated. Basic colours: white, black, silver, antracite dark gray and special color options available upon request.

Alüminyum gövde. Opal veya mikroprizmatik difüzör seçenekleri mevcuttur. Şebeke gerilimi: 220-240V / 50-60Hz. 1-10V, DALI, Casambi DIM, Dinamik Beyaz DALI, Dinamik Beyaz CASAMBI seçenekleri mevcuttur. Acil durum kiti sistemi entegre edilebilir. Temel renkler: beyaz, siyah, gümüş, antrasit koyu gri ve istek üzerine özel renk seçenekleri mevcuttur.

## Product Data / Ürün Bilgileri

Article Nr. (AVOLUX)	102.LL.27207.(Power).(CRI).(Colour)
Material / Malzeme	Aluminium
Outer Diameter / Dış Çap	80x80cm
Height / Yükseklik	75mm
Weight / Ağırlık	6.5kg
Mouting method / Montaj yöntemi	Surface Mounted / Sıvaüstü

## Lighting Technology / Aydınlatma Teknolojisi

Colour Temperature / Renk Sıcaklığı	2700K	3000K	3500K	4000K	5000K
Luminous flux / Işık akısı	13500lm	13932lm	14148lm	14687lm	14904lm
System efficiency / Sistem verimliliği	130lm/W	134lm/W	136lm/W	141lm/W	143lm/W
Colour rendering / Renk oluşturma	80CRI	80CRI	80CRI	80CRI	80CRI
Beam angle / Işin açısı	114°	114°	114°	114°	114°
Light Output / Işık çıkışı	Only Direct / Sadece Direkt				

## Operating technology of the Luminaires / Armatürlerin çalışma teknolojisi

System Output / Sistem Çıkışı	104W
Voltage Type / Voltaj Tipi	220-240VAC
AC nominal voltage max. / AC nominal voltaj maks.	264VAC
Frequenz max. / Frekans maks.	63Hz
Lamp / Lamba	LED
Protection class / Koruma sınıfı	IP40
Degree of protection / Koruma derecesi	Class I
Control / Kontrol	ON - OFF / DALI / CASAMBI / TUNABLE WHITE
Rated Life time L80/B10 at 25°C	>50000 hrs

# Panos Radius Slim Direct/Indirect

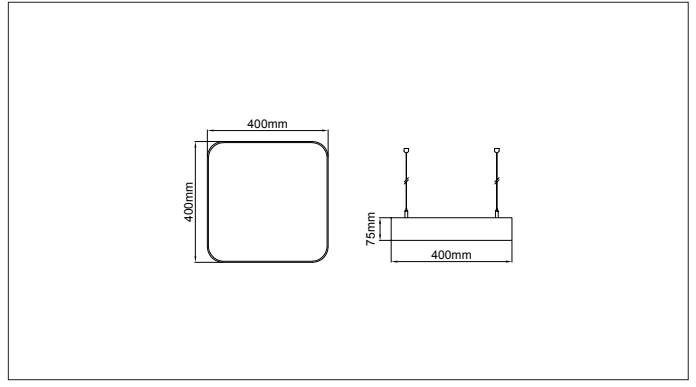
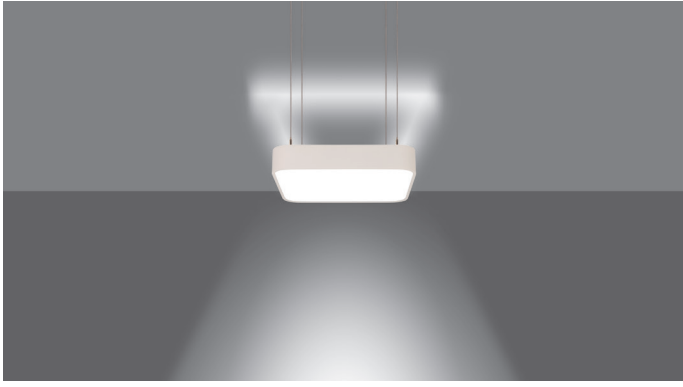

\* Code example / Kod örneği:

102.LL.25307.034.830.01

1 2 3 4

1- Product code / Armatür kodu

2- Power / Güç

3- CRI / Kelvin

4- Colour / Ürün renk

5- Control type / Kontrol tipi

4 / Product Color / Ürün Renk



Beam Angle / Işık Açısı

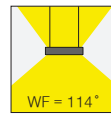

Suspension Wire

Sarkıtma Teli



## Description / Tanım

Aluminium body. Opal or microprismatic diffuser options available. Mains voltage: 220-240V / 50-60Hz. 1-10V, DALI, Casambi DIM, Tunable White DALI, Tunable White CASAMBI, options available. Emergency kit system can be integrated. Basic colours: white, black, silver, antracite dark gray and special color options available upon request. Steel suspension wire with up to 5mt lenght option together with standart or central baldachine.

Alüminyum gövde. Opal veya mikroprizmatik difüzör seçenekleri mevcuttur. Şebeke gerilimi: 220-240V / 50-60Hz. 1-10V, DALI, Casambi DIM, Dinamik Beyaz DALI, Dinamik Beyaz CASAMBI seçenekleri mevcuttur. Acil durum kiti sistemi entegre edilebilir. Temel renkler: beyaz, siyah, gümüş, antrasit koyu gri ve istek üzerine özel renk seçenekleri mevcuttur. Standart veya merkezi baldachine ile birlikte 5mt'ye kadar uzunluk seçeneği ile çelik asma teli.

## Product Data / Ürün Bilgileri

Article Nr. (AVOLUX)	102.LL.25307.(Power).(CRI).(Colour)
Material / Malzeme	Aluminium
Outer Diameter / Dış Çap	40x40cm
Height / Yükseklik	75mm
Weight / Ağırlık	2.5kg
Mouting method / Montaj yöntemi	Suspendant / Sarkıt

## Lighting Technology / Aydınlatma Teknolojisi

Colour Temperature / Renk Sıcaklığı	2700K	3000K	3500K	4000K	5000K
Total Luminous flux / Toplam Işık akısı	3170lm	3271lm	3321lm	3449lm	3499lm
System efficiency / Sistem verimliliği	93lm/W	96lm/W	98lm/W	101lm/W	103lm/W
Luminous flux Direct / Işık akısı Direkt	2593lm	2676lm	2717lm	2821lm	2862lm
Luminous flux Indirect / Işık akısı Endirekt	577lm	595lm	604lm	628lm	637lm
Colour rendering / Renk oluşturma	80CRI	80CRI	80CRI	80CRI	80CRI
Beam angle / Işın açısı	114°	114°	114°	114°	114°
Light Output / Işık çıkışı	Direct - Indirect / Direkt - Endirekt				

## Operating technology of the Luminaires / Armatürlerin çalışma teknolojisi

System Output / Sistem Çıkışı	34W (23W Direkt - 11W İndirect)
Voltage Type / Voltaj Tipi	220-240VAC
AC nominal voltage max. / AC nominal voltaj maks.	264VAC
Frequenz max. / Frekans maks.	63Hz
Lamp / Lamba	LED
Protection class / Koruma sınıfı	IP40
Degree of protection / Koruma derecesi	Class I
Control / Kontrol	ON - OFF / DALI / CASAMBI / TUNABLE WHITE
Rated Life time L80/B10 at 25°C	>50000 hrs

# Panos Radius Slim Direct/Indirect

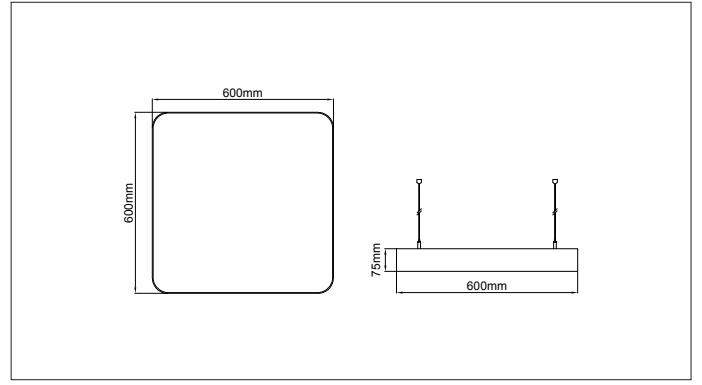
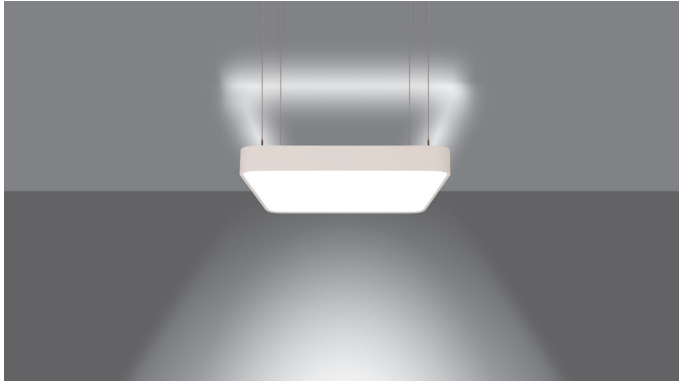

\* Code example / Kod örneği:

102.LL.26307 . 077 . 830 . 01

- 1- Product code / Armatür kodu
- 2- Power / Güç
- 3- CRI / Kelvin
- 4- Colour / Ürün renk
- 5- Control type / Kontrol tipi

#### 4 / Product Color / Ürün Renk



#### Beam Angle / Işık Açısı

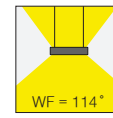

Suspension Wire  
Sarkıtma Teli



#### Description / Tanım

Aluminium body. Opal or microprismatic diffuser options available. Mains voltage: 220-240V / 50-60Hz. 1-10V, DALI, Casambi DIM, Tunable White DALI, Tunable White CASAMBI, options available. Emergency kit system can be integrated. Basic colours: white, black, silver, antracite dark gray and special color options available upon request. Steel suspension wire with up to 5mt lenght option together with standart or central baldachine.

Alüminyum gövde. Opal veya mikroprizmatik difüzör seçenekleri mevcuttur. Şebeke gerilimi: 220-240V / 50-60Hz. 1-10V, DALI, Casambi DIM, Dinamik Beyaz DALI, Dinamik Beyaz CASAMBI seçenekleri mevcuttur. Acil durum kiti sistemi entegre edilebilir. Temel renkler: beyaz, siyah, gümüş, antrasit koyu gri ve istek üzerine özel renk seçenekleri mevcuttur. Standart veya merkezi baldachine ile birlikte 5mt'ye kadar uzunluk seçeneği ile çelik asma teli.

#### Product Data / Ürün Bilgileri

Article Nr. (AVOLUX)	102.LL.26307.(Power).(CRI).(Colour)
Material / Malzeme	Aluminium
Outer Diameter / Dış Çap	60x60cm
Height / Yükseklik	75mm
Weight / Ağırlık	4.5kg
Mouting method / Montaj yöntemi	Suspendant / Sarkıt

#### Lighting Technology / Aydınlatma Teknolojisi

Colour Temperature / Renk Sıcaklığı	2700K	3000K	3500K	4000K	5000K
Total Luminous flux / Toplam Işık akısı	8054lm	8312lm	8441lm	8763lm	8892lm
System efficiency / Sistem verimliliği	105lm/W	108lm/W	110lm/W	114lm/W	115lm/W
Luminous flux Direct / Işık akısı Direkt	6553lm	6763lm	6868lm	7130lm	7235lm
Luminous flux Indirect / Işık akısı Endirekt	1501lm	1549lm	1573lm	1633lm	1657lm
Colour rendering / Renk oluşturma	80CRI	80CRI	80CRI	80CRI	80CRI
Beam angle / Işın açısı	114°	114°	114°	114°	114°
Light Output / Işık çıkışı	Direct - Indirect / Direkt - Endirekt				

#### Operating technology of the Luminaires / Armatürlerin çalışma teknolojisi

System Output / Sistem Çıkışı	77W (53W Direkt - 24W Indirect)
Voltage Type / Voltaj Tipi	220-240VAC
AC nominal voltage max. / AC nominal voltaj maks.	264VAC
Frequenz max. / Frekans maks.	63Hz
Lamp / Lamba	LED
Protection class / Koruma sınıfı	IP40
Degree of protection / Koruma derecesi	Class I
Control / Kontrol	ON - OFF / DALI / CASAMBI / TUNABLE WHITE
Rated Life time L80/B10 at 25°C	>50000 hrs

# Panos Radius Slim Direct/Indirect

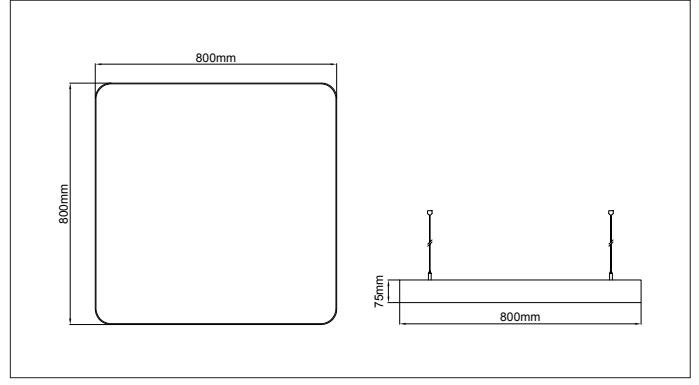

\* Code example / Kod örneği:

102.LL.27307 . 130 . 830 . 01

- 1- Product code / Armatür kodu
- 2- Power / Güç
- 3- CRI / Kelvin
- 4- Colour / Ürün renk
- 5- Control type / Kontrol tipi

4 / Product Color / Ürün Renk



Beam Angle / Işık Açısı

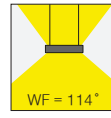

Suspension Wire

Sarkıtma Teli



## Description / Tanım

Aluminium body. Opal or microprismatic diffuser options available. Mains voltage: 220-240V / 50-60Hz. 1-10V, DALI, Casambi DIM, Tunable White DALI, Tunable White CASAMBI, options available. Emergency kit system can be integrated. Basic colours: white, black, silver, antracite dark gray and special color options available upon request. Steel suspension wire with up to 5mt lenght option together with standart or central baldachine.

Alüminyum gövde. Opal veya mikroprizmatik difüzör seçenekleri mevcuttur. Şebeke gerilimi: 220-240V / 50-60Hz. 1-10V, DALI, Casambi DIM, Dinamik Beyaz DALI, Dinamik Beyaz CASAMBI seçenekleri mevcuttur. Acil durum kiti sistemi entegre edilebilir. Temel renkler: beyaz, siyah, gümüş, antrasit koyu gri ve istek üzerine özel renk seçenekleri mevcuttur. Standart veya merkezi baldachine ile birlikte 5mt'ye kadar uzunluk seçeneği ile çelik asma teli.

## Product Data / Ürün Bilgileri

Article Nr. (AVOLUX)	102.LL.27307.(Power).(CRI).(Colour)
Material / Malzeme	Aluminium
Outer Diameter / Dış Çap	80x80cm
Height / Yükseklik	75mm
Weight / Ağırlık	6.5kg
Mouting method / Montaj yöntemi	Suspendant / Sarkıt

## Lighting Technology / Aydınlatma Teknolojisi

Colour Temperature / Renk Sıcaklığı	2700K	3000K	3500K	4000K	5000K
Total Luminous flux / Toplam Işık akısı	15058lm	15540lm	15781lm	16383lm	16625lm
System efficiency / Sistem verimliliği	116lm/W	120lm/W	122lm/W	127lm/W	128lm/W
Luminous flux Direct / Işık akısı Direkt	13500lm	13932lm	14148lm	14687lm	14904lm
Luminous flux Indirect / Işık akısı Endirekt	1558lm	1608lm	1633lm	1696lm	1721lm
Colour rendering / Renk oluşturma	80CRI	80CRI	80CRI	80CRI	80CRI
Beam angle / Işın açısı	114°	114°	114°	114°	114°
Light Output / Işık çıkışı	Direct - Indirect / Direkt - Endirekt				

## Operating technology of the Luminaires / Armatürlerin çalışma teknolojisi

System Output / Sistem Çıkışı	129.5W (104W Direkt - 25.5W İndirect)
Voltage Type / Voltaj Tipi	220-240VAC
AC nominal voltage max. / AC nominal voltaj maks.	264VAC
Frequenz max. / Frekans maks.	63Hz
Lamp / Lamba	LED
Protection class / Koruma sınıfı	IP40
Degree of protection / Koruma derecesi	Class I
Control / Kontrol	ON - OFF / DALI / CASAMBI / TUNABLE WHITE
Rated Life time L80/B10 at 25°C	>50000 hrs

# LDT Files / LDT Dataları



I02.LL.25107

I02.LL.25207

I02.LL.25307

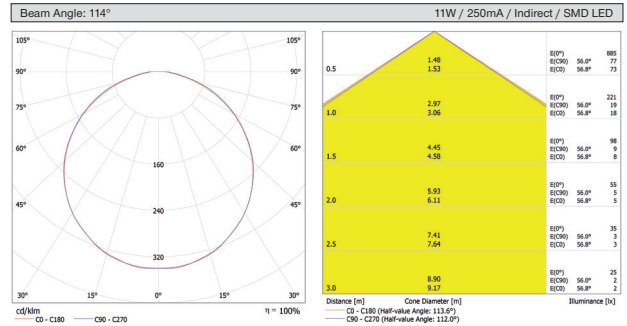
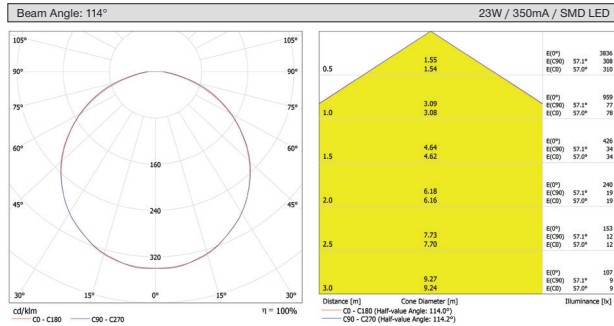

I02.LL.26107

I02.LL.26207

I02.LL.26307

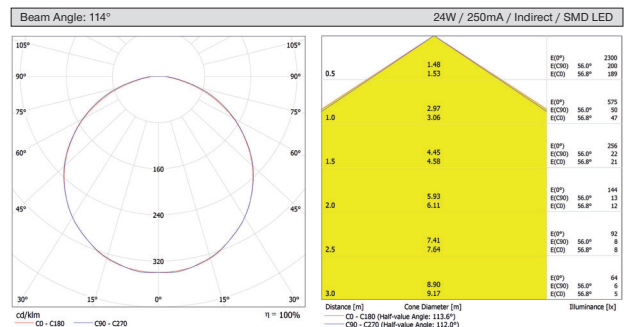
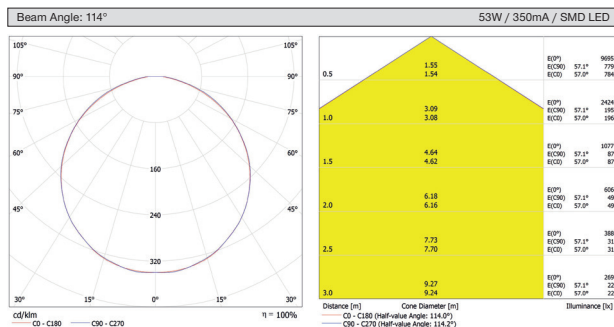

I02.LL.27107

I02.LL.27207

I02.LL.27307

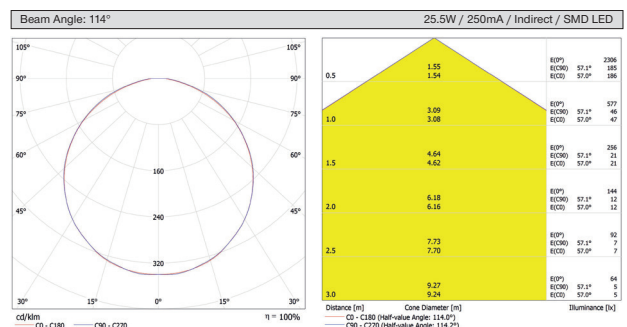
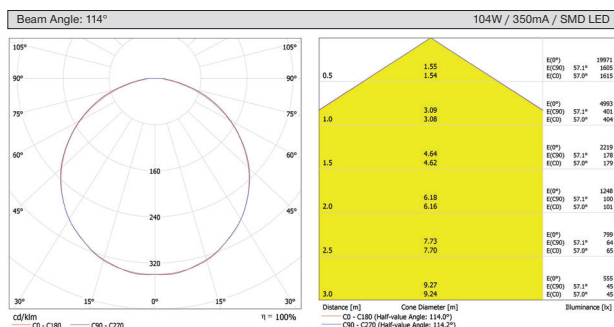

Linea Led Series / Linea Led Serisi