



Flora

 IP67

 IK10

120
lm/W

5
YEARS
WARRANTY



Flora

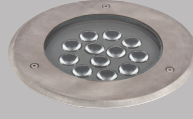

Flora Midi



Flora Mini

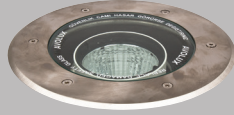

Flora COB



Flora Mini COB

Operating Conditions / Çalışma Koşulları

Thanks to its clever design heatsinks, our Flora range can operate at extreme conditions between -25° +50° degree ambient temperature.

Akıllı soğutma tasarımı sayesinde Flora yere gömme serisi armatürleri -25° +50° derece aralığına sahip ortam koşullarında çalışabilmektedir.

-25°C

+50°C

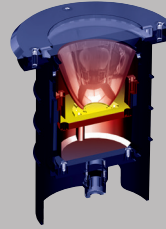

Recessed mounted uplighter. Connecting cable and safety plug for portable installation. The used Led technique offers durability and optimal light output with low power consumption.

The main body of the luminaires are cast aluminium that absorbs the pressure loads. The luminaires can be driven over by vehicles.

Front frame is 316 grade Stainless steel resistant against high corrosion factors of outdoor conditions.

In order to be easily flush mounted on ground, plastic mounting outer body is being supplied with the luminaire.

Both symmetric and wallwasher optic versions available.

Yere gömme led armatür serisi. Yenilikçi led tekniği sayesinde optimal ve tasarruflu ışık çıkışı. Enerji girişi ve kabo atlaması armatürü açmadan dışardan kolayca sağlanabilir.

Ana gövde enjeksiyon alüminyum olup araçların tekerlekleri dahil dış basınca dayanıklıdır.

Ön çerçeve 316 kalite paslanmaz olup dış ortamın yüksek korozyon faktörlerine karşı dayanıklıdır.

Armatür yere veya toprağa kolayca montaj edilebilmesi için plastik dış montaj kovası ile beraber verilmektedir.

Simetrik ve duvar boyama lens optic versyonları mevcuttur.

EN

- Outdoor on floor luminaire with high protection class.
- Safe structures through the tempered pressure resistant glasses.
- Easy applicable luminaires through the inground recessed boxes.
- Max weight resistance : 3000 Kg.
- Led colour temperatures optionally 2700K, 3000K, 3500K, 4000K, 5000K and 6500K.
- 316 grade Stainless steel frame.
- Symmetrical light distribution super spot, spot, medium, wide and wide flood options available.
- Oval and Single asymmetric light distribution options available at every size.

TR

- Yüksek koruma sınıflı dış mekan yer spotu.
- Basınca dayanıklı kalın tamperli camı sayesinde dış mekanda güvenle kullanabilirsiniz.
- Zemin sıva altı kasaları sayesinde uzun ömürlüdür.
- Max. taşıma ağırlığı : 3000 Kg.
- 2700K, 3000K, 3500K, 4000K, 5000K ve 6500K renk sıcaklığı seçenekleri mevcuttur.
- 316 kalite paslanmaz çerçeve.
- Simetrik çok dar, dar, orta, geniş ve çok geniş ışık açısı alternatifleri bulunmaktadır.
- Her boyda oval ve asimetric ışık açısı seçenekleri mevcuttur.

Critical Feature / Kritik Özellik

A- When luminaire is on, it will generate high temperature and create negative pressure and brings vapor inside that would create water droplets on glass and increase percentage of failure. That's why water stopper device is critical to avoid vapor go inside luminaire.

A- Armatür çalıştığında yaratacağı ısı ürünün içine doğru basınç yaratacağından su buharı kablo içinden armatür içine rahatça girebilir ve arıza yüzdesini artırabilir. Bu sebeple 220V kablosunun orta bölümüne ilave olarak su stoper koyularak ürün içinde buharlaşmayı en aza indiriyoruz.

B- Every uplighter Avolux produces is being supplied by IP67 socket for safe installation and prevent water travel inside luminaire through the cable.

B- Avolux ürettiği tüm yere gömme armatürlerin yanında güvenli montaj için IP67 soketi temin etmektedir. Bu sayede armatüre kablo içinden su girme ihtimali ortadan kalkmaktadır.



Features / Özellikler

1- High efficient optic with narrow, medium, wide and assymetric distribution options.
Dar, orta, geniş ve asimetrik ışık dağılımlarına sahip yüksek verimli optik.

2- Highest efficiency Led's with 2700K, 3000K, 3500K, 4000K, 5000K and 6500K CCT options.
2700K, 3000K, 3500K, 4000K, 5000K ve 6500K renklere sahip yüksek verimli LED.

3- 316 grade stainless steel frame.
316 kalite paslanmaz çerçeve.

4- High quality LED driver that can function both in low and high Ta conditions with five years warranty. On/off, 1-10V and DALI options available.
Çok düşük ve yüksek Ta değerlerinde çalışabilen yüksek kalite LED trafosu. On/off, 1-10V ve DALI seçenekleri bulunmaktadır.

5- Plastic mounting outer box ease installation process.
Plastik montaj dış kutusu sayesinde armatür kolayca monte edilebilir.

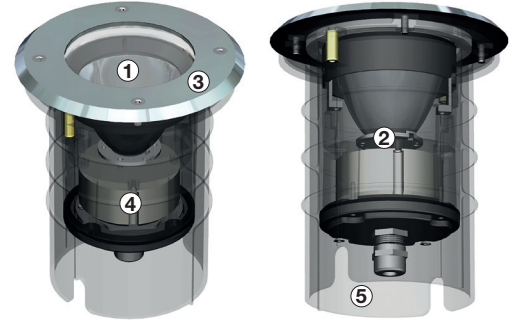

Weight Resistance / Ağırlığa Dayanıklılık

Flora uplight range have resistance to torsion and shear, up to 3000KG.

Flora yere gömme armatür serisi 3000KG ağırlığa kadar dayanıklılık gösterir.



Accessories / Aksesuarlar

We can integrate honeycomb louver to Flora range to reduce glare as an option.

Flora serisine kamaşmayı azaltmak için bal peteği filtresi adapte edilebilir.



Flora



5 / Product Color / Ürün Renk



Stainless = 07

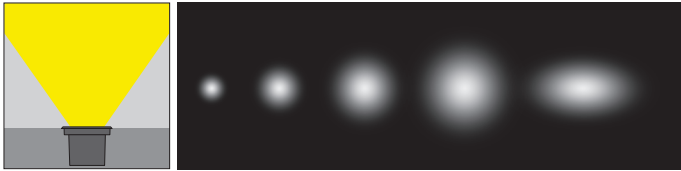

* See page 572 for ldt files. / Işık eğrileri için sayfa 572 bakınız.

Technical Drawing / Teknik Çizim

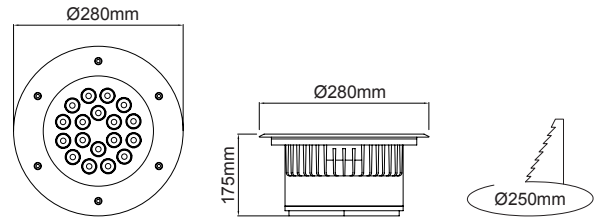

Flora / O07.UP.01610



Power / Güç	CRI	Order Code / Sipariş Kodu	Kelvin	Lümen T _C =50° Lümen
22W	CRI>80	O07.UP.01610 . (.) . (...) . (.) . (.) . (.)	2700K	2339
			3000K	2367
			3500K	2475
			4000K	2529
			5000K	2556
6500K	2584			
15W	CRI>80	O07.UP.01610 . (.) . (...) . (.) . (.) . (.)	Red / Kırmızı	1257
21W	CRI>80	O07.UP.01610 . (.) . (...) . (.) . (.) . (.)	Green / Yeşil	2132
21W	CRI>80	O07.UP.01610 . (.) . (...) . (.) . (.) . (.)	Blue / Mavi	1061
21W	CRI>80	O07.UP.01610 . (.) . (...) . (.) . (.) . (.)	Amber	2314

* Code example / Kod örneği:

O07.UP.01610 . 22 . 827 . SP . 07

- 1- Product code / Armatür kodu
- 2- Power / Güç
- 3- CRI / Kelvin
- 4- Reflector angle / Reflektör açısı
- 5- Colour / Ürün renk

2	Watt - Driving Current / Watt - Sürüş Akımı	3	CRI / Kelvin	4	Reflector Angle / Reflektör Açısı	5	Product Color / Ürün Renk					
								22	22W - 1050mA	827	CRI>80 - 2700K	625
			830	CRI>80 - 3000K	525	Green / Yeşil	ME	25° - Medium				
			835	CRI>80 - 3500K	470	Blue / Mavi	FL	30° - Flood				
			840	CRI>80 - 4000K	590	Amber	WF	45° - Wide Flood				
			850	CRI>80 - 5000K			OV	40° x 18° - Oval				
			865	CRI>80 - 6500K								

Flora ASM



5 / Product Color / Ürün Renk

Technical Drawing / Teknik Çizim

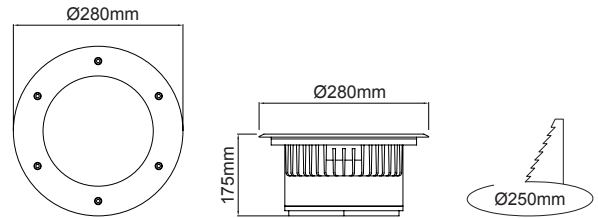
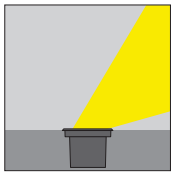

Flora ASM / O07.UP.01611



Power / Güç	CRI	Order Code / Sipariş Kodu	Kelvin	Lümen T _c =50° Lümen
15W	CRI>80	O07.UP.01611 . (...) . (...) . (...) . (...)	2700K	1293
			3000K	1308
			3500K	1368
			4000K	1398
			5000K	1413
15W	CRI>80	O07.UP.01611 . (...) . (...) . (...) . (...)	6500K	1428
			Red / Kırmızı	1008
			Green / Yeşil	1631
			Blue / Mavi	808
19W	CRI>80	O07.UP.01611 . (...) . (...) . (...) . (...)	Amber	1850

* Code example / Kod örneği:

O07.UP.01611 . 15 . 827 . ASM . 07

- 1- Product code / Armatür kodu
- 2- Power / Güç
- 3- CRI / Kelvin
- 4- Reflector angle / Reflektör açısı
- 5- Colour / Ürün renk

Complete Code / Komple Kod	2	3	4	5	
	Watt - Driving Current / Watt - Sürüş Akımı	CRI / Kelvin	Reflector Angle / Reflektör Açısı	Product Color / Ürün Renk	
15	15W - 350mA	827 CRI>80 - 2700K	SP Asymmetric	07 stainless	
		625 Red / Kırmızı			
		830 CRI>80 - 3000K			525 Green / Yeşil
		835 CRI>80 - 3500K			470 Blue / Mavi
		840 CRI>80 - 4000K			590 Amber
		850 CRI>80 - 5000K			
865 CRI>80 - 6500K					

Flora Midi



5 / Product Color / Ürün Renk

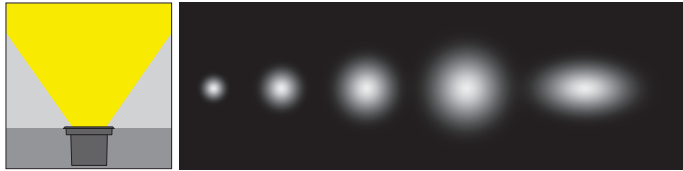

* See page 572 for ldt files. / Işık eğrileri için sayfa 572 bakınız.

Technical Drawing / Teknik Çizim

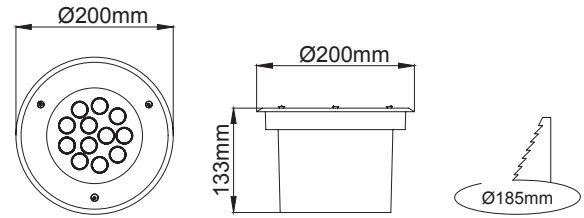

Flora Midi / O07.UP.01615



Power / Güç	CRI	Order Code / Sipariş Kodu	Kelvin	Lümen T _c =50° Lümen
14W	CRI>80	O07.UP.01615 . (.) . (...) . (.) . (.) . (.)	2700K	1874
			3000K	1982
			3500K	2026
			4000K	2048
			5000K	2070
			6500K	2092
10W	CRI>80	O07.UP.01615 . (.) . (...) . (.) . (.) . (.)	Red / Kırmızı	838
13W	CRI>80	O07.UP.01615 . (.) . (...) . (.) . (.) . (.)	Green / Yeşil	1421
13W	CRI>80	O07.UP.01615 . (.) . (...) . (.) . (.) . (.)	Blue / Mavi	707
13W	CRI>80	O07.UP.01615 . (.) . (...) . (.) . (.) . (.)	Amber	1542

* Code example / Kod örneği:
O07.UP.01615 . 14 . 827 . SP . 07

1 2 3 4 5

- 1- Product code / Armatür kodu
- 2- Power / Güç
- 3- CRI / Kelvin
- 4- Reflector angle / Reflektör açısı
- 5- Colour / Ürün renk

2	Watt - Driving Current / Watt - Sürüş Akımı	3		4	Reflector Angle / Reflektör Açısı	5	Product Color / Ürün Renk
		CRI	Kelvin				
14	14W - 350mA	827	CRI>80 - 2700K	625	Red / Kırmızı	SP	07 stainless
		830	CRI>80 - 3000K	525	Green / Yeşil	ME	
		835	CRI>80 - 3500K	470	Blue / Mavi	FL	
		840	CRI>80 - 4000K	590	Amber	WF	
		850	CRI>80 - 5000K			OV	
		865	CRI>80 - 6500K				

Flora Midi ASM



5 / Product Color / Ürün Renk

Technical Drawing / Teknik Çizim

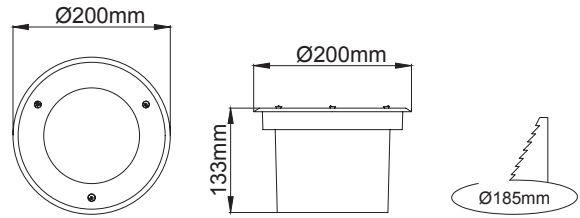
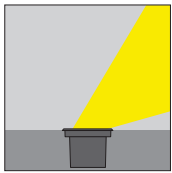

Flora Midi ASM / O07.UP.01616



* Code example / Kod örneği:

O07.UP.01616 . 11 . 827 . ASM . 07

1- Product code / Armatür kodu

2- Power / Güç

3- CRI / Kelvin

4- Reflector angle / Reflektör açısı

5- Colour / Ürün renk

Power / Güç	CRI	Order Code / Sipariş Kodu	Kelvin	Lümen T _c =50° Lümen
11W	CRI>80	O07.UP.01616 . (...) . (...) . (...) . (...)	2700K	1000
			3000K	1012
			3500K	1058
			4000K	1081
			5000K	1093
6500K	1115			
7W	CRI>80	O07.UP.01616 . (...) . (...) . (...) . (...)	Red / Kırmızı	544
10W	CRI>80	O07.UP.01616 . (...) . (...) . (...) . (...)	Green / Yeşil	924
10W	CRI>80	O07.UP.01616 . (...) . (...) . (...) . (...)	Blue / Mavi	460
10W	CRI>80	O07.UP.01616 . (...) . (...) . (...) . (...)	Amber	1002

Complete Code / Komple Kod	2	3	4	5	
	Watt - Driving Current / Watt - Sürüş Akımı	CRI / Kelvin	Reflector Angle / Reflektör Açısı	Product Color / Ürün Renk	
11	11W - 350mA	827 CRI>80 - 2700K	SP Asymmetric	07 stainless	
		625 Red / Kırmızı			
		830 CRI>80 - 3000K			525 Green / Yeşil
		835 CRI>80 - 3500K			470 Blue / Mavi
		840 CRI>80 - 4000K			590 Amber
		850 CRI>80 - 5000K			
865 CRI>80 - 6500K					

Flora Mini



5 / Product Color / Ürün Renk

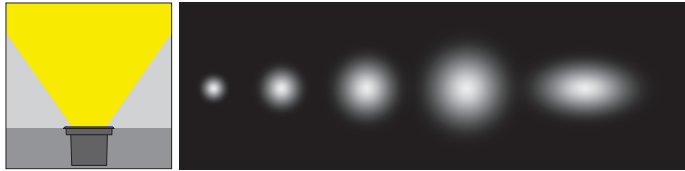

* See page 573 for ldt files. / Işık eğrileri için sayfa 573 bakınız.

Technical Drawing / Teknik Çizim

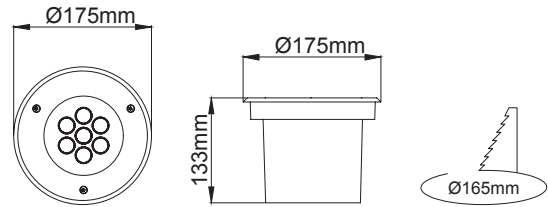

Flora Mini / O07.UP.01620



Power / Güç	CRI	Order Code / Sipariş Kodu	Kelvin	Lümen T _C =50° Lümen
9W	CRI>80	O07.UP.01620 . (.) . (...) . (.) . (.)	2700K	1126
			3000K	1140
			3500K	1192
			4000K	1219
			5000K	1232
6500K	1244			
5W	CRI>80	O07.UP.01620 . (.) . (...) . (.) . (.)	Red / Kırmızı	419
7W	CRI>80	O07.UP.01620 . (.) . (...) . (.) . (.)	Green / Yeşil	711
7W	CRI>80	O07.UP.01620 . (.) . (...) . (.) . (.)	Blue / Mavi	353
7W	CRI>80	O07.UP.01620 . (.) . (...) . (.) . (.)	Amber	771

* Code example / Kod örneği:

O07.UP.01620 . 9 . 827 . SP . 07

1 2 3 4 5

- 1- Product code / Armatür kodu
- 2- Power / Güç
- 3- CRI / Kelvin
- 4- Reflector angle / Reflektör açısı
- 5- Colour / Ürün renk

Complete Code / Komple Kod	2	3	4	5
	Watt - Driving Current / Watt - Sürüş Akımı	CRI / Kelvin	Reflector Angle / Reflektör Açısı	Product Color / Ürün Renk
9	9W - 350mA	827 CRI>80 - 2700K	625 Red / Kırmızı	07 stainless
		830 CRI>80 - 3000K	525 Green / Yeşil	
		835 CRI>80 - 3500K	470 Blue / Mavi	
		840 CRI>80 - 4000K	590 Amber	
		850 CRI>80 - 5000K		
		865 CRI>80 - 6500K		

Flora Mini ASM



5 / Product Color / Ürün Renk

Technical Drawing / Teknik Çizim

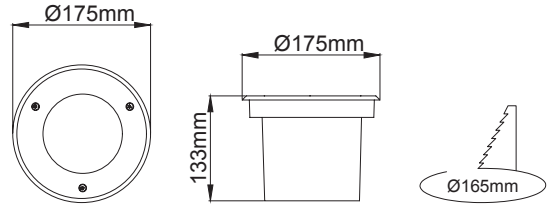
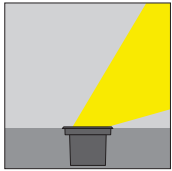

Flora Mini ASM / O07.UP.01621

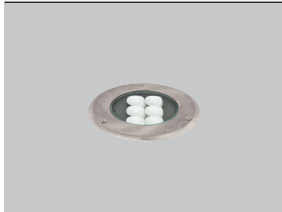

Power / Güç	CRI	Order Code / Sipariş Kodu	Kelvin	Lümen T _c =50° Lümen
8W	CRI>80	O07.UP.01621 . (..) . (..) . (..) . (..)	2700K	657
			3000K	665
			3500K	695
			4000K	710
			5000K	718
6500K	726			
5W	CRI>80	O07.UP.01621 . (..) . (..) . (..) . (..)	Red / Kırmızı	363
7W	CRI>80	O07.UP.01621 . (..) . (..) . (..) . (..)	Green / Yeşil	616
7W	CRI>80	O07.UP.01621 . (..) . (..) . (..) . (..)	Blue / Mavi	306
7W	CRI>80	O07.UP.01621 . (..) . (..) . (..) . (..)	Amber	668

* Code example / Kod örneği:

O07.UP.01621 . 8 . 827 . ASM . 07

- 1- Product code / Armatür kodu
- 2- Power / Güç
- 3- CRI / Kelvin
- 4- Reflector angle / Reflektör açısı
- 5- Colour / Ürün renk

Complete Code / Komple Kod	2	3	4	5	
	Watt - Driving Current / Watt - Sürüş Akımı	CRI / Kelvin	Reflector Angle / Reflektör Açısı	Product Color / Ürün Renk	
8	8W - 350mA	827 CRI>80 - 2700K	SP Asymmetric	07 stainless	
		625 Red / Kırmızı			
		830 CRI>80 - 3000K			525 Green / Yeşil
		835 CRI>80 - 3500K			470 Blue / Mavi
		840 CRI>80 - 4000K			590 Amber
		850 CRI>80 - 5000K			
	865 CRI>80 - 6500K				

Flora COB

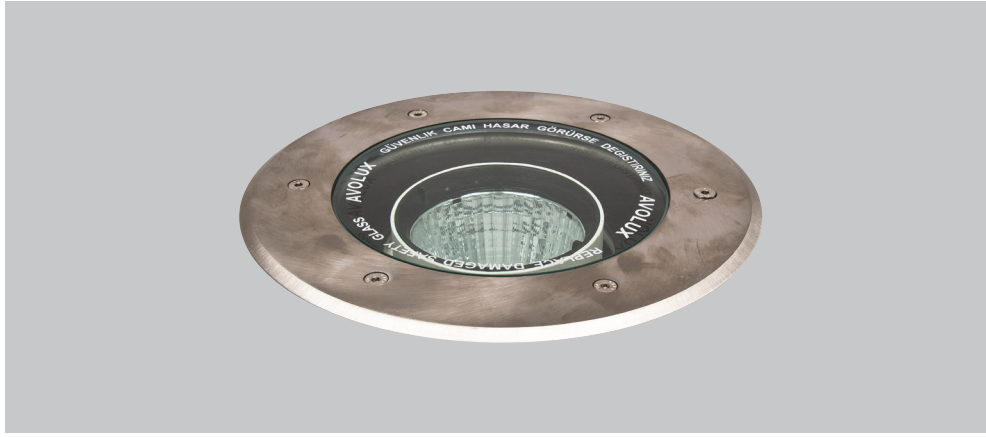

5 / Product Color / Ürün Renk



Stainless = 07

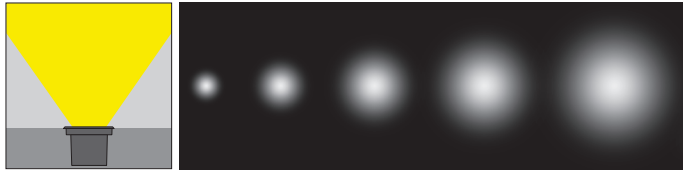

* See page 573 for ldt files. / Işık eğrileri için sayfa 573 bakınız.

Technical Drawing / Teknik Çizim

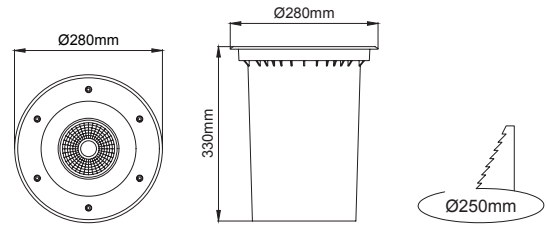

Flora COB / 007.UP.01630

Power / Güç	CRI	Order Code / Sipariş Kodu	Kelvin	Lümen T _C =50° Lümen
			35W	CRI>80
			3000K	4079
			3500K	4174
			4000K	4269
			5000K	4294
			6500K	X

* Code example / Kod örneği:

007.UP.01630 . 35 . 827 . SS . 07

- 1- Product code / Armatür kodu
- 2- Power / Güç
- 3- CRI / Kelvin
- 4- Reflector angle / Reflektör açısı
- 5- Colour / Ürün renk

2	Watt - Driving Current / Watt - Sürüş Akımı	3	CRI / Kelvin	4	Reflector Angle / Reflektör Açısı	5	Product Color / Ürün Renk
31	31W - 800mA	830	CRI>80 - 3000K	SP	20° - Spot		
28	28W - 700mA	835	CRI>80 - 3500K	ME	30° - Medium		
		840	CRI>80 - 4000K	FL	40° - Flood		
		850	CRI>80 - 5000K	WF	60° - Wide Flood		

Flora Mini COB



5 / Product Color / Ürün Renk

Technical Drawing / Teknik Çizim

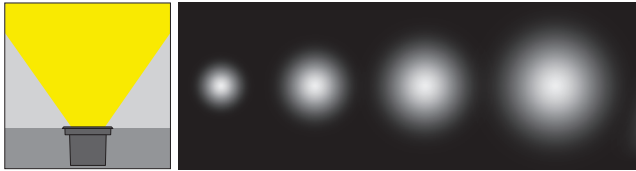
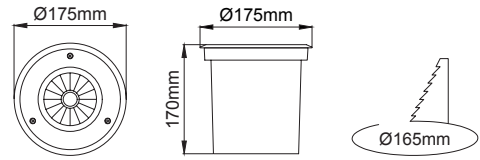

* See page 574 for ldt files. / Işık eğrileri için sayfa 574 bakınız.

Flora Mini COB / O07.UP.01640

Power / Güç	CRI	Order Code / Sipariş Kodu	Kelvin	Lümen T _c =50° Lümen
			28W	CRI>80
			3000K	3186
			3500K	3260
			4000K	3335
			5000K	3353
			6500K	X

* Code example / Kod örneği:

O07.UP.01640 . 28 . 827 . SP . 07

1 2 3 4 5

- 1- Product code / Armatür kodu
- 2- Power / Güç
- 3- CRI / Kelvin
- 4- Reflector angle / Reflektör açısı
- 5- Colour / Ürün renk

2	Watt - Driving Current / Watt - Sürüş Akımı	3	CRI / Kelvin	4	Reflector Angle / Reflektör Açısı	5	Product Color / Ürün Renk
	28		28W - 700mA		827		CRI>80 - 2700K
24	24W - 600mA	830	CRI>80 - 3000K	ME	30° - Medium		
20	20W - 500mA	835	CRI>80 - 3500K	FL	40° - Flood		
		840	CRI>80 - 4000K	WF	60° - Wide Flood		
		850	CRI>80 - 5000K				