

Giz

Key advantages

- Slim rectangular luminaire for outdoor installation on wall.
- Installation: Luminaire is supplied with plastic outer installation box for easy mounting.
- The body is protected by a special antioxidizing treatment for a higher resistance against aggressive agents. Salt spray test being applied to ensure stability of finishing.
- The heat generated by the light source is dissipated by means of a passive cooling system.
- The luminaire is equipped with a piece of cable for mains to provide easy-to-make connection.

EN

- Corrosion resistant die-cast aluminium body.
- Mains voltage: 220-240V / 50-60Hz.
- Clever thermal design with internal cooling pins.
- Led colour temperatures are optionally 2700K, 3000K, 3500K, 4000K, 5000K and 6500K.
- Internal silicon gaskets ensure IP protection.
- All external screws are stainless steel.
- Double layer polyester powder paint resistant to corrosion and salt spray fog.
- High colour consistency: <3 SDCM
- L80 B10 50000hrs and five years warranty.

Kilit Avantajları

- Slim dikdörtgen forma sahip duvara monte armatür serisi.
- Montaj: Kolay montaj için armatür plastik dış alçı kasaya sahiptir.
- Gövde boyası oksitlenmeye karşı özel korumalıdır. Armatürler tuz testi ile oksitlenmeye karşı koruma tip testine tabi tutulmaktadır.
- Pasif soğutucu sistemine sahiptir.
- Armatür 220V enerji girişi kablosu üzerinde verilmektedir. Enerji bağlantısı için armatürü açmaya gerek yoktur.

TR

- Korozyona dayanıklı alüminyum enjeksiyon gövde.
- 220-240V / 50-60Hz enerji girişli.
- 2700K, 3000K, 3500K, 4000K, 5000K ve 6500K renk sıcaklığı seçenekleri mevcuttur.
- Silikon contalar ile IP koruması sorunsuz sağlanır.
- Tüm dış vidalar paslanmazdır.
- Çift katmanlı polyester toz boya sayesinde korozyona ve tuza dayanıklı.
- Yüksek renk uyumu: <3 SDCM
- L80 B10 50000 saat ve beş yıl garantisi.



5 / Product Color / Ürün Renk

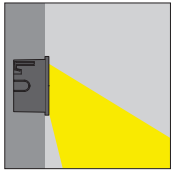

Technical Drawing / Teknik Çizim

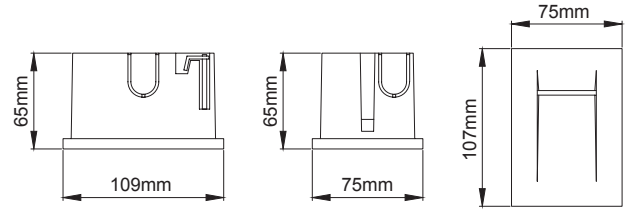

Giz / O07.WA.00011



Power / Güç	CRI	Order Code / Sipariş Kodu	Kelvin	Lümen T _c =50° Lümen
4W	CRI>80	O07.WL.00011 . (..) . (..) . (..) . (..)	2700K	497
			3000K	507
			3500K	517
			4000K	528
			5000K	532
			6500K	539

* Code example / Kod örneği:

O07.WA.00011 . 4 . 827 . ASM . 01

- 1- Product code / Armatür kodu
- 2- Power / Güç
- 3- CRI / Kelvin
- 4- Reflector angle / Reflektör açısı
- 5- Colour / Ürün renk

2	Watt / Watt	3	CRI / Kelvin	4	Reflector Angle / Reflektör Açısı	5	Product Color / Ürün Renk
4	4W	827	CRI>80 - 2700K		ASM Asymmetric		01 white
		830	CRI>80 - 3000K				02 ral 9010
		835	CRI>80 - 3500K				03 black
		840	CRI>80 - 4000K				04 gray
		850	CRI>80 - 5000K				05 dark gray
		865	CRI>80 - 6500K				06 special color



5 / Product Color / Ürün Renk

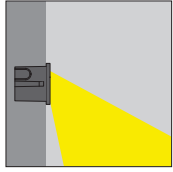

Technical Drawing / Teknik Çizim

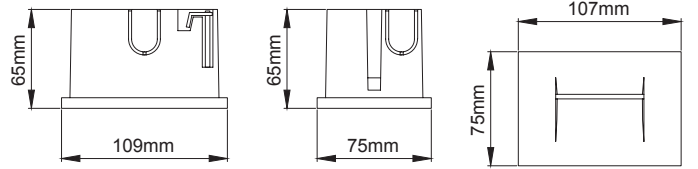

Giz / O07.WA.00012



Power / Güç	CRI	Order Code / Sipariş Kodu	Kelvin	Lümen T _c =50° Lümen
4W	CRI>80	O07.WL.00012 . (..) . (...) . (..) . (..)	2700K	497
			3000K	507
			3500K	517
			4000K	528
			5000K	532
			6500K	539

* Code example / Kod örneği:

O07.WA.00012 . 4 . 827 . ASM . 01

- 1- Product code / Armatür kodu
- 2- Power / Güç
- 3- CRI / Kelvin
- 4- Reflector angle / Reflektör açısı
- 5- Colour / Ürün renk

2	3	4	5
Watt / Watt	CRI / Kelvin	Reflector Angle / Reflektör Açısı	Product Color / Ürün Renk
4W - 350mA	827 CRI>80 - 2700K 830 CRI>80 - 3000K 835 CRI>80 - 3500K 840 CRI>80 - 4000K 850 CRI>80 - 5000K 865 CRI>80 - 6500K	ASM Asymmetric	01 white 02 ral 9010 03 black 04 gray 05 dark gray 06 special color

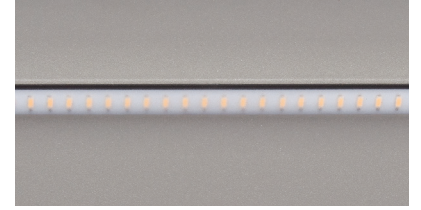
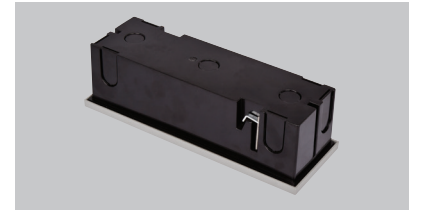

5 / Product Color / Ürün Renk

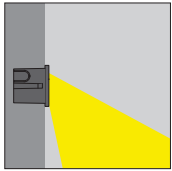

Technical Drawing / Teknik Çizim

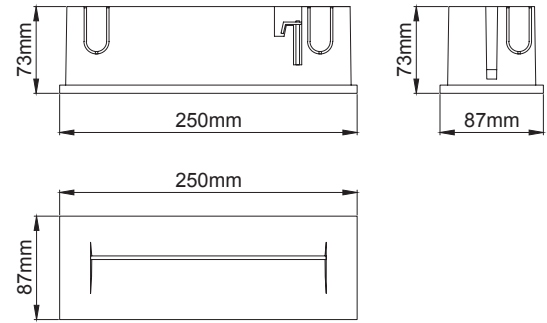

Giz / O07.WA.00013



Power / Güç	CRI	Order Code / Sipariş Kodu	Kelvin	Lümen T _c =50° Lümen
12W	CRI>80	O07.WL.00013 . (..) . (..) . (..) . (..)	2700K	1491
			3000K	1521
			3500K	1552
			4000K	1584
			5000K	1600
			6500K	1616

* Code example / Kod örneği:

O07.WA.00013 . 12 . 827 . ASM . 01

- 1- Product code / Armatür kodu
- 2- Power / Güç
- 3- CRI / Kelvin
- 4- Reflector angle / Reflektör açısı
- 5- Colour / Ürün renk

2 Watt / Watt	3 CRI / Kelvin	4 Reflector Angle / Reflektör Açısı	5 Product Color / Ürün Renk
12 12W - 350mA	827 CRI>80 - 2700K	ASM Asymmetric	01 white
	830 CRI>80 - 3000K		02 ral 9010
	835 CRI>80 - 3500K		03 black
	840 CRI>80 - 4000K		04 gray
	850 CRI>80 - 5000K		05 dark gray
	865 CRI>80 - 6500K		06 special color