

SİLİNDİR 48V Tracklight

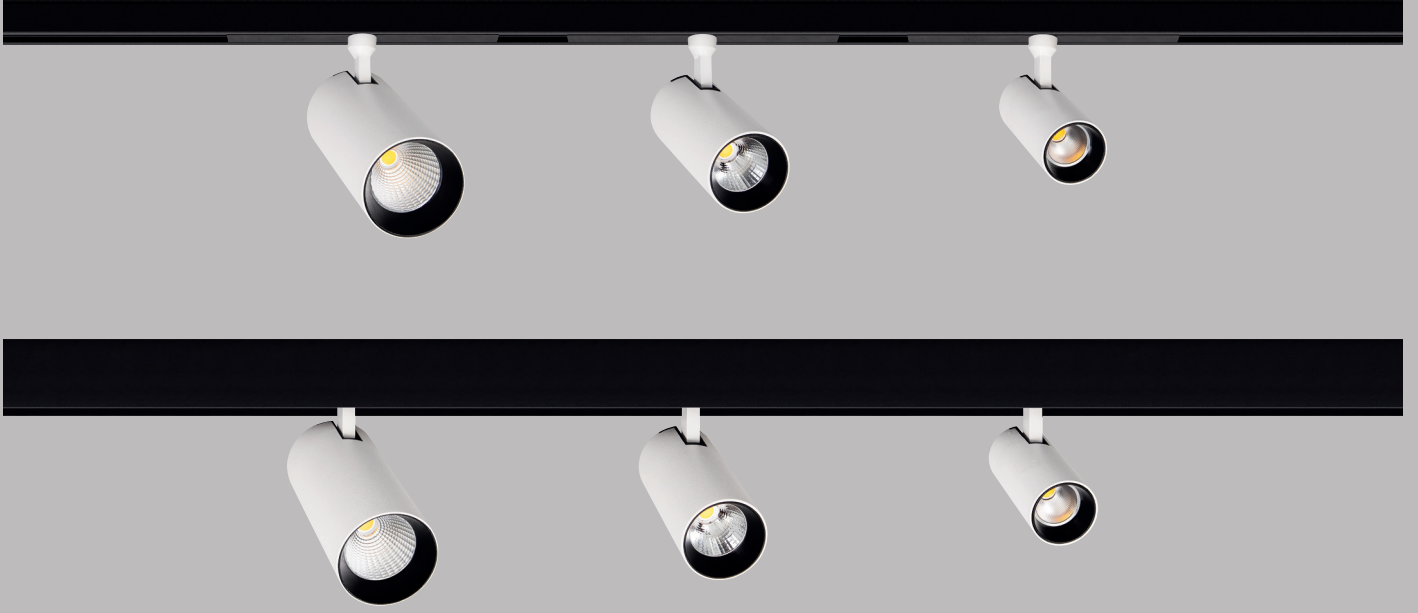

SİLİNDİR family is now available in 48V low-voltage tracklights version in three different size options. 48V Track system creates great flexibility in lighting and architectural design and creates possibility of endless combinations. CRI>98 option together with different kelvin and beam angle variety, makes this family unique.

The light modules are easy to insert and remove from track. Its minimalistic dimensions helps to create aesthetic indoor environments.

Different accesories can be integrated to Silindir 48V range and also various DIM options are available.

SİLİNDİR Spot ailesi artık 48V ray sistemine de uyumlu. 48V ray sistemi iç mekan aydınlatma uygulamalarında büyük bir kolaylık ve esneklik sağlamaktadır. Sayısız farklı uygulamaların yapılabileceği bu seride CRI>98 seçeneğinin yanında farklı açı ve ışık rengi seçenekleri sayesinde benzersizdir.

Armatürler ray sistemine kolayca takılıp çıkarılabilir. Minimal hatları sayesinde Silindir 48V serisi iç mekan tasarım uygulamalarına estetik dokunuşlar sağlar.

Bu seriye farklı aksesuar uygulanabildiği gibi birçok farklı DIM seçeneği de bulunmaktadır.

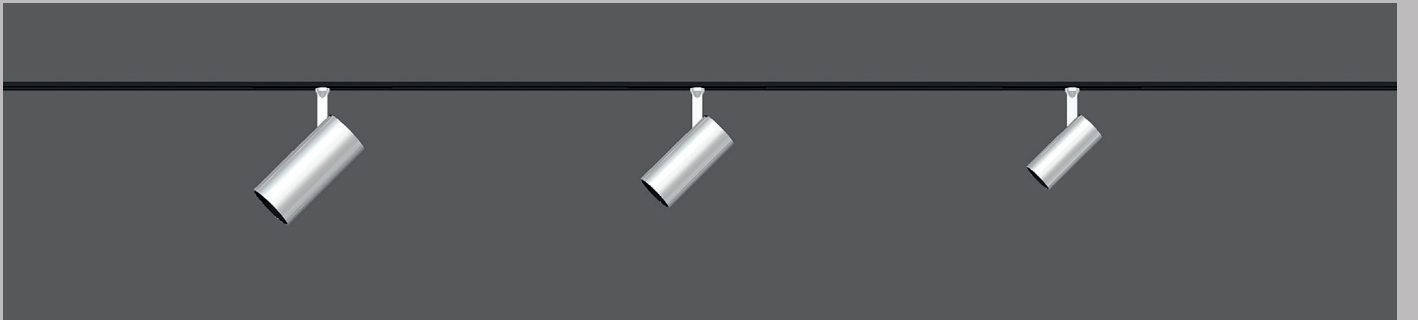

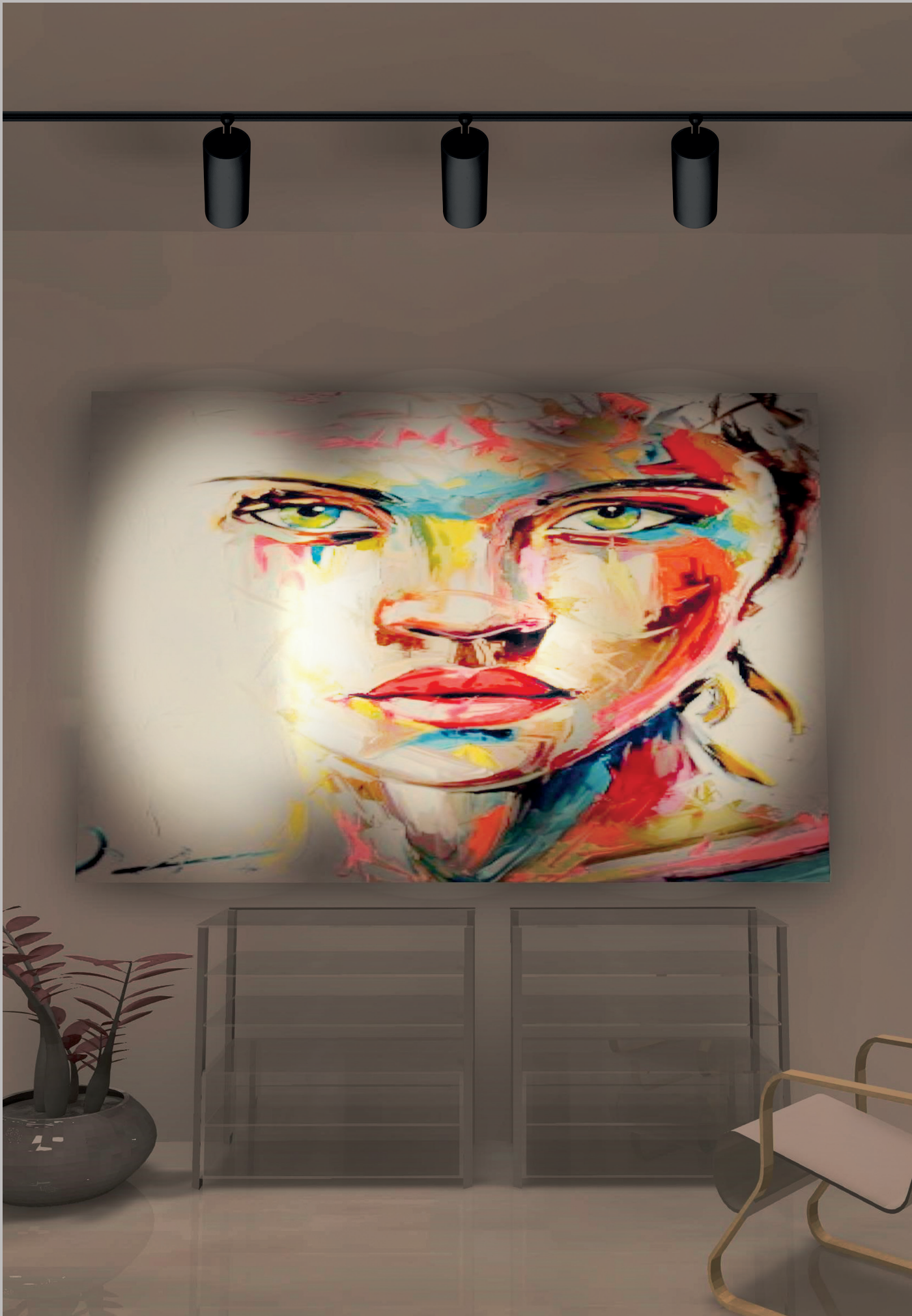

Silindir 48V



Silindir 60 Short Arm

Silindir 50 Short Arm

Silindir 40 Short Arm



Silindir 60 Long Arm

Silindir 50 Long Arm

Silindir 40 Long Arm

Silindir with Short Arm / Silindir Kısa Kol

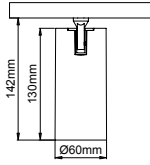

Track mounted 48V low voltage spotlight with cylinder housing and short arm in die-cast aluminium for slim 48V Stucchi tracks.

İnce formulu 48V Stucchi rayları için dizayn edilmiş kısa kollu silindir formulu rayspot. Gövde ve kol alüminyum enjeksiyon yapılıdır.

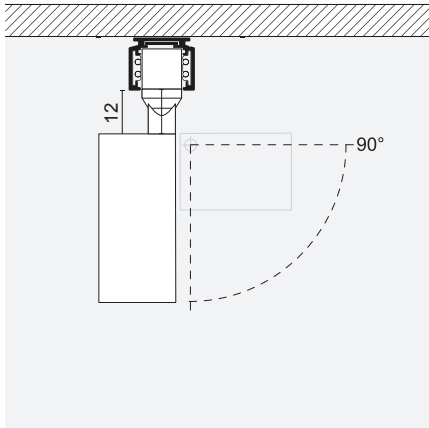

Silindir with Long Arm / Silindir Uzun Kol

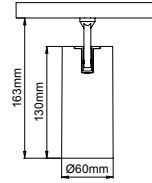

Track mounted 48V low voltage spotlight with cylinder housing and long arm in die-cast aluminium for deep size 48V Stucchi tracks.

İnce formulu 48V derin yapılu Stucchi rayları için dizayn edilmiş uzun kollu silindir formulu rayspot. Gövde ve kol alüminyum enjeksiyon yapılıdır.

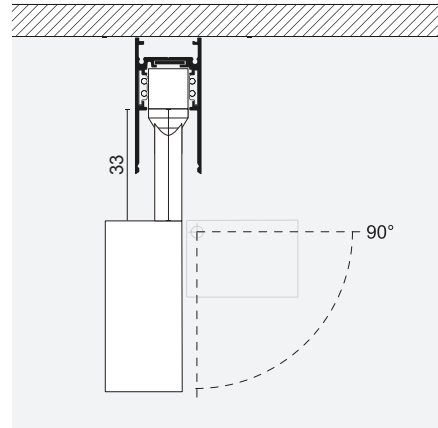

Warm DIM / Sıcak DIM

Warm dimming technology allows a colour temperature gradual reduction from 3000K to 1800K, allowing soft and natural passage to different warm light conditions. Avolux Silindir 48V range can function with this technology.

Sıcak DIM teknolojisi 3000K'den 1800K'e kademeli ve yumuşak sıcak ışık geçişi sağlar. Avolux Silindir 48V serisi bu teknolojiye sahiptir.



Silindir 48V

Wireless DIM / Kablosuz DIM

Avolux offers wireless DIM control on its Silindir 48V range that provides easy control and saves time on wiring during installation.

Avolux Silindir 48V serisinde kablosuz DIM seçeneği sunarak kolay kontrol olanağı sunar. Ürün montaj kurulum esnasında daha az kablolama ile zamandan tasarruf sağlar.



Design / Dizayn

Silindir 48V spot range is magnificent design for low voltage tracklight applications. Minimal housing with three different size options integrated to DC/DC driver.

Silindir 48V serisi düşük voltaj ray armatür uygulamaları için mükemmeldir. Üç farklı minimal ölçü seçeneğine sahip olup DC/DC trafoludur.

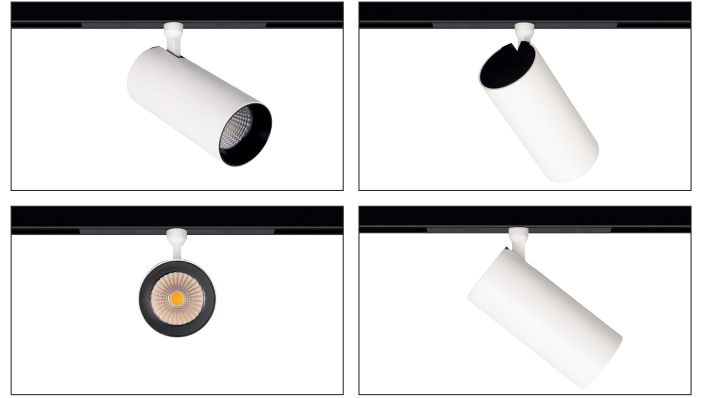

Features / Özellikler

- 1- High efficient reflector optic with spot, medium and wide distribution options.
Dar, orta ve geniş açı ışık dağılımlarına sahip yüksek verimli reflektör optik.
- 2- Highest efficiency COB led's with 2700K, 3000K, 3500K, 4000K and 5000K CCT options.
2700K, 3000K, 3500K, 4000K ve 5000K renklere sahip yüksek verimli COB LED modül.
- 3- Clever design internal cooling fins. No visibility of cooling fins from outside.
İç Soğutma kanallarına sahip akıllı soğutma tasarımı. Dışardan soğutma kanalları gözükmemektedir.
- 4- High quality DC/DC LED driver built inside 48V track with zero visibility.
Tamamen 48V rayın içine gömülü DC/DC Led trafolu.
- 5- 90° vertical and 350° horizontal adjustable mounting arm with mechanical lock system. Long and short arm options available on request.
Dikeyde 90°, yatayda 350° hareket edebilir mekanik kilitleme sistemine sahip montaj kolu. İsteğe bağlı kısa ve uzun kol seçenekleri mevcuttur.

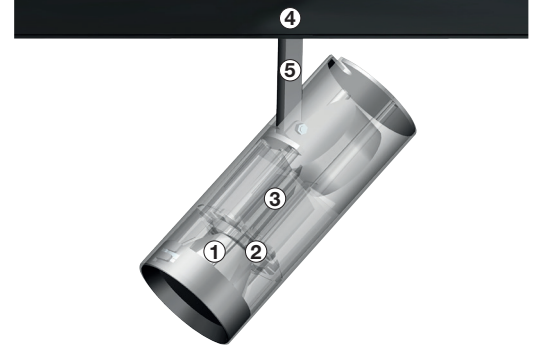

CRI

Avolux offers both CRI>90 and CRI>98 colour rendering index options in its Silindir 48V spotlight range.

Avolux Silindir 48V serisi armatürlerinde CRI>90 ve CRI>98 renk seçeneklerini sağlayabilmektedir.



Silindir 48V

How system simply works / Sistem basitçe nasıl çalışır



Mains to be connected to 48V central driver and 48V driver to be connected to low voltage track with input adaptor. Total power of tracklights to be connected to central 48V driver should not exceed total power of the driver itself. Driver can be used on/off, DALI or Wireless DIM options.

220-240V şebeke elektriği merkezi 48V trafoya bağlanır. Trafo'dan da 48V ray sistemine enerji giriş adaptörü ile DC voltaj verilir. Burada dikkat edilmesi gereken husus sistemde kullanılan armatürlerin toplam gücü trafonun toplam gücünü geçmemelidir. Merkezi trafo on/off seçeneği yanında DALI ve Kablosuz DIM seçenekleri de kullanılarak sistemdeki armatürler DIM edilebilir.

Minimalizm / Minimal yapı

Our main aim in this range is to keep sizes as small as possible to create architectural designs.

Bu serideki ana hedefimiz ölçüleri mümkün olan en küçük seviyede tutarak göze hoş gelen tasarımlar yaratmaktır.



Special Colour options / Özel Kaplama seçenekleri





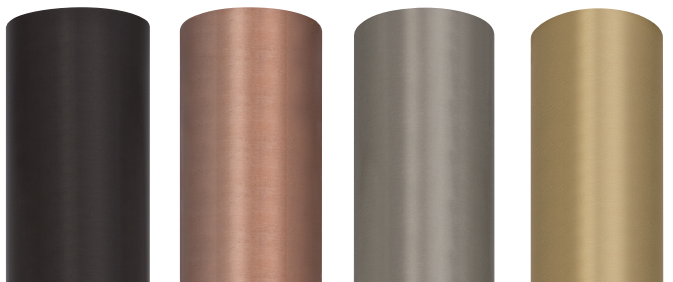

Rustic black, copper, matt chrome and brass coating options on surface of Silindir 48V.

Rustik siyah, bakır, mat krom ve pirinç kaplama seçenekleri Silindir 48V armatür serisine uygulanabilir.









Silindir 48V

DIM Options / DIM seçenekleri

							
		Silindir 60 Short Arm	Silindir 50 Short Arm	Silindir 40 Short Arm	Silindir 60 Long Arm	Silindir 50 Long Arm	Silindir 40 Long Arm
ON-OFF		•	•	•	•	•	•
PHASE CUT DIM / FAZ DIM	Ext.Code / Kod: .PH						
1-10V DIM	Ext.Code / Kod: .VO	•	•	•	•	•	•
DALI DIM	Ext.Code / Kod: .DA	•	•	•	•	•	•
WIRELESS DIM / KABLOSUZ DİM	Ext.Code / Kod: .WD	•	•	•	•	•	•
WARM DIM / SICAK DİM	Ext.Code / Kod: .WM	•	•	•	•	•	•
TUNABLE WHITE / DİNAMİK BEYAZ	Ext.Code / Kod: .TW						

Accessories / Aksesuarlar

							
		Silindir 60 Short Arm	Silindir 50 Short Arm	Silindir 40 Short Arm	Silindir 60 Long Arm	Silindir 50 Long Arm	Silindir 40 Long Arm
Colour Filter / Renkli Filtre	Ext.Code / Kod: .CLF	•	•	•	•	•	•
Antiglare Screen / Kamaşma Önleyici	Ext.Code / Kod: .VKO	•	•	•	•	•	•
Visor / Işık Siperi	Ext.Code / Kod: .VIS	•	•	•	•	•	•
Honeycomb Filter / Petekli Filtre	Ext.Code / Kod: .VBP	•	•	•	•	•	•
Barn Door / Yönlendirici Flap	Ext.Code / Kod: .VFL						

Silindir 60



5 / Product Color / Ürün Renk



4 / Reflector Angle / Reflektör Açısı

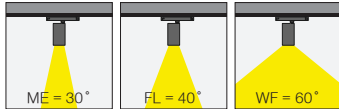

* See page 244 for ldt files. / İşık eğrileri için sayfa 244 bakınız.

EN

- Die-cast aluminium body.
- 48V DC Voltage Input.
- Clever thermal design with passive heat dissipation.
- With DC/DC in-track adaptor compatible to Stucchi Low-Voltage track system.
- 90° rotation on vertical and 350° angle on horizontal axis with mechanical aiming lock.
- Clear safety glass.
- Classic dimming system of 1-10V and DALI Dim options.
- High tech control systems of Wireless Dim and Warm Dim.
- Basic colours: White, Black, Gray, Dark Gray, RAL9010 and special color options.
- Available accessories are Honeycomb Filter, Colour Filter, Antiglare Screen and Visor.
- Medium, Flood and Wide Flood beam angle options.
- Up to 96lm/W efficiency.

Technical Drawing / Teknik Çizim / SHORT ARM

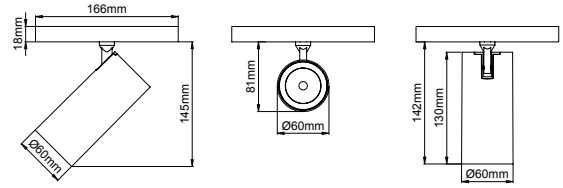

Technical Drawing / Teknik Çizim / LONG ARM

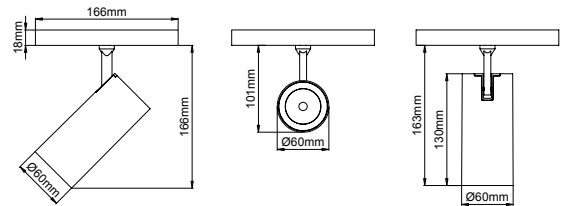

TR

- Alüminyum enjeksiyon gövde.
- 48V DC giriřli.
- Pasif sođutma teknolojisine sahip akıllı sođutma tasarımı.
- Stucchi 48V ray sistemine uygun DC/DC trafo adaptörlü.
- Dikeyde 90°, yatayda 350° hareket kabiliyetine sahip.
- Tamperli cam.
- Klasik 1-10V ve DALI DIM seçenekleri uygulanabilir.
- Yüksek teknoloji kontrol sistemleri olan Kablosuz DIM ve Sıcak DIM uygulamaları yapılabilir.
- Standart renk seçenekleri: Beyaz, Siyah, Gri, Koyu Gri, RAL9010 yanında isteđe bađlı özel renk seçenekleri uygulanabilir.
- Balpeteđi Filtresi, Renk Filtresi, Kamařma Önleyici ve Vizör aksesuar seçenekleri uygulanabilir.
- Orta, Geniř ve Çok Geniř reflektör açısı seçenekleri mevcuttur.
- 96lm/W'a varan verim.

Silindir 60

Silindir 60 Short Arm / I01.MLT.91200



* Code example / Kod örneği:

I01.MLT.91200 . 20 . 827 . SP . 01

- 1- Product code / Armatür kodu
- 2- Power / Güç
- 3- CRI / Kelvin
- 4- Reflector angle / Reflektör açısı
- 5- Colour / Ürün renk

Power / Güç	CRI	Order Code / Sipariş Kodu	Kelvin	Lümen T _c =50° Lümen
20W	CRI>90	I01.MLT.91200 . (.) . (...) . (.) . (..)	2700K	2042
			3000K	2104
			3500K	2146
			4000K	2189
			5000K	X
CRI>98	I01.MLT.91200 . (.) . (...) . (.) . (..)	2700K	1490	
		3000K	1535	
		4000K	1600	

2	Watt - Driving Current / Watt - Sürüş Akımı	3				4		5	
		CRI / Kelvin				Reflector Angle / Reflektör Açısı		Product Color / Ürün Renk	
20	20W - 500mA	927	CRI>90 - 2700K	9827	CRI>98 - 2700K	 	ME 30° - Medium FL 40° - Flood WF 60° - Wide Flood		01 white
		930	CRI>90 - 3000K	9830	CRI>98 - 3000K				02 ral 9010
		935	CRI>90 - 3500K	9840	CRI>98 - 4000K				03 black
		940	CRI>90 - 4000K						04 gray
							05 dark gray		
							06 special color		

Silindir 60 Long Arm / I01.MLT.92200



* Code example / Kod örneği:

I01.MLT.92200 . 20 . 827 . SP . 01

- 1- Product code / Armatür kodu
- 2- Power / Güç
- 3- CRI / Kelvin
- 4- Reflector angle / Reflektör açısı
- 5- Colour / Ürün renk

Power / Güç	CRI	Order Code / Sipariş Kodu	Kelvin	Lümen T _c =50° Lümen
20W	CRI>90	I01.MLT.92200 . (.) . (...) . (.) . (..)	2700K	2042
			3000K	2104
			3500K	2146
			4000K	2189
			5000K	X
CRI>98	I01.MLT.92200 . (.) . (...) . (.) . (..)	2700K	1490	
		3000K	1535	
		4000K	1600	

2	Watt - Driving Current / Watt - Sürüş Akımı	3				4		5	
		CRI / Kelvin				Reflector Angle / Reflektör Açısı		Product Color / Ürün Renk	
20	20W - 500mA	927	CRI>90 - 2700K	9827	CRI>98 - 2700K	 	ME 30° - Medium FL 40° - Flood WF 60° - Wide Flood		01 white
		930	CRI>90 - 3000K	9830	CRI>98 - 3000K				02 ral 9010
		935	CRI>90 - 3500K	9840	CRI>98 - 4000K				03 black
		940	CRI>90 - 4000K						04 gray
							05 dark gray		
							06 special color		

Silindir 50



5 / Product Color / Ürün Renk

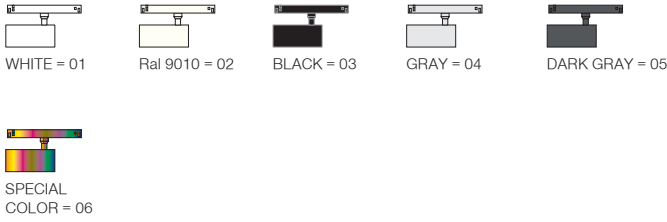

4 / Reflector Angle / Reflektör Açısı

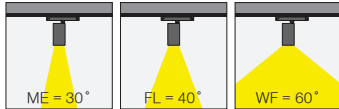

* See page 245 for ldt files. / Işık eğrileri için sayfa 245 bakınız.

Technical Drawing / Teknik Çizim / SHORT ARM

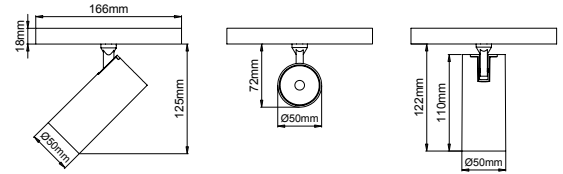

Technical Drawing / Teknik Çizim / LONG ARM

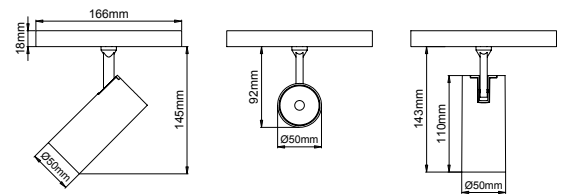

EN

- Die-cast aluminium body.
- 48V DC Voltage Input.
- Clever thermal design with passive heat dissipation.
- With DC/DC in-track adaptor compatible to Stucchi Low-Voltage track system.
- 90° rotation on vertical and 350° angle on horizontal axis with mechanical aiming lock.
- Clear safety glass.
- Classic dimming system of 1-10V and DALI Dim options.
- High tech control systems of Wireless Dim and Warm Dim.
- Basic colours: White, Black, Gray, Dark Gray, RAL9010 and special color options.
- Available accessories are Honeycomb Filter, Colour Filter, Antiglare Screen and Visor.
- Medium, Flood and Wide Flood beam angle options.
- Up to 98lm/W efficiency.

TR

- Alüminyum enjeksiyon gövde.
- 48V DC girişi.
- Pasif soğutma teknolojisine sahip akıllı soğutma tasarımı.
- Stucchi 48V ray sistemine uygun DC/DC trafo adaptörlü.
- Dikeyde 90°, yatayda 350° hareket kabiliyetine sahip.
- Tamperli cam.
- Klasik 1-10V ve DALI DIM seçenekleri uygulanabilir.
- Yüksek teknoloji kontrol sistemleri olan Kablosuz DIM ve Sıcak DIM uygulamaları yapılabilir.
- Standart renk seçenekleri: Beyaz, Siyah, Gri, Koyu Gri, RAL9010 yanında isteğe bağlı özel renk seçenekleri uygulanabilir.
- Balpeteği Filtresi, Renk Filtresi, Kamaşma Önleyici ve Vizör aksesuar seçenekleri uygulanabilir.
- Orta, Geniş ve Çok Geniş reflektör açısı seçenekleri mevcuttur.
- 98lm/W'a varan verim.

Silindir 50

Silindir 50 Short Arm / I01.MLT.91201



* Code example / Kod örneği:

I01.MLT.91201 . 15 . 827 . ME . 01
1 2 3 4 5

- 1- Product code / Armatür kodu
- 2- Power / Güç
- 3- CRI / Kelvin
- 4- Reflector angle / Reflektör açısı
- 5- Colour / Ürün renk

Power / Güç	CRI	Order Code / Sipariş Kodu	Kelvin	Lümen T _c =50° Lümen
15W	CRI>90	I01.MLT.91201 . (.) . (...) . (.) . (.)	2700K	1515
			3000K	1562
			3500K	1595
			4000K	1628
			5000K	X
CRI>98	I01.MLT.91201 . (.) . (...) . (.) . (.)	2700K	1105	
		3000K	1140	
		4000K	1190	

2	Watt - Driving Current / Watt - Sürüş Akımı	3		CRI / Kelvin		4	Reflector Angle / Reflektör Açısı	5		Product Color / Ürün Renk				
		15	10W - 350mA	927	9827			930	9830	935	9840	940	01	02
		927	CRI>90 - 2700K	9827	CRI>98 - 2700K		ME	30° - Medium		01	white			
		930	CRI>90 - 3000K	9830	CRI>98 - 3000K		FL	40° - Flood		02	ral 9010			
		935	CRI>90 - 3500K	9840	CRI>98 - 4000K		WF	60° - Wide Flood		03	black			
		940	CRI>90 - 4000K							04	gray			
										05	dark gray			
										06	special color			

Silindir 50 Long Arm / I01.MLT.92201



* Code example / Kod örneği:

I01.MLT.92201 . 15 . 827 . ME . 01
1 2 3 4 5

- 1- Product code / Armatür kodu
- 2- Power / Güç
- 3- CRI / Kelvin
- 4- Reflector angle / Reflektör açısı
- 5- Colour / Ürün renk

Power / Güç	CRI	Order Code / Sipariş Kodu	Kelvin	Lümen T _c =50° Lümen
15W	CRI>90	I01.MLT.92201 . (.) . (...) . (.) . (.)	2700K	1515
			3000K	1562
			3500K	1595
			4000K	1628
			5000K	X
CRI>98	I01.MLT.92201 . (.) . (...) . (.) . (.)	2700K	1105	
		3000K	1140	
		4000K	1190	

2	Watt - Driving Current / Watt - Sürüş Akımı	3		CRI / Kelvin		4	Reflector Angle / Reflektör Açısı	5		Product Color / Ürün Renk				
		15	15W - 350mA	927	9827			930	9830	935	9840	940	01	02
		927	CRI>90 - 2700K	9827	CRI>98 - 2700K		ME	30° - Medium		01	white			
		930	CRI>90 - 3000K	9830	CRI>98 - 3000K		FL	40° - Flood		02	ral 9010			
		935	CRI>90 - 3500K	9840	CRI>98 - 4000K		WF	60° - Wide Flood		03	black			
		940	CRI>90 - 4000K							04	gray			
										05	dark gray			
										06	special color			

Silindir 40



5 / Product Color / Ürün Renk

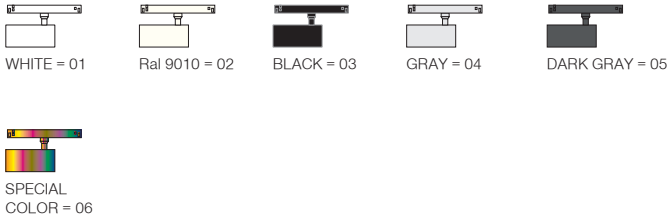

Technical Drawing / Teknik Çizim / SHORT ARM

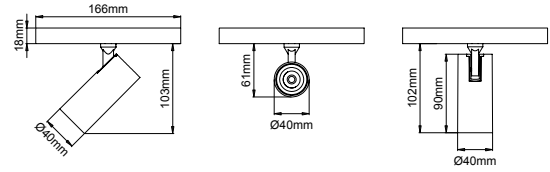

Technical Drawing / Teknik Çizim / LONG ARM

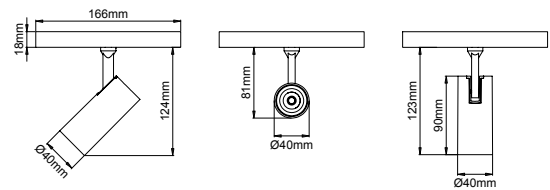

4 / Reflector Angle / Reflektör Açısı

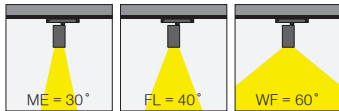

* See page 247 for ldt files. / İşik eğrileri için sayfa 247 bakınız.

EN

- Die-cast aluminium body.
- 48V DC Voltage Input.
- Clever thermal design with passive heat dissipation.
- With DC/DC in-track adaptor compatible to Stucchi Low-Voltage track system.
- 90° rotation on vertical and 350° angle on horizontal axis with mechanical aiming lock.
- Clear safety glass.
- Classic dimming system of 1-10V and DALI Dim options.
- High tech control systems of Wireless Dim and Warm Dim.
- Basic colours: White, Black, Gray, Dark Gray, RAL9010 and special color options.
- Available accessories are Honeycomb Filter, Colour Filter, Antiglare Screen and Visor.
- Medium, Flood and Wide Flood beam angle options.
- Up to 71lm/W efficiency.

TR

- Alüminyum enjeksiyon gövde.
- 48V DC girişi.
- Pasif soğutma teknolojisine sahip akıllı soğutma tasarımı.
- Stucchi 48V ray sistemine uygun DC/DC trafo adaptörlü.
- Dikeyde 90°, yatayda 350° hareket kabiliyetine sahip.
- Tamperli cam.
- Klasik 1-10V ve DALI DIM seçenekleri uygulanabilir.
- Yüksek teknoloji kontrol sistemleri olan Kablosuz DIM ve Sıcak DIM uygulamaları yapılabilir.
- Standart renk seçenekleri: Beyaz, Siyah, Gri, Koyu Gri, RAL9010 yanında isteğe bağlı özel renk seçenekleri uygulanabilir.
- Balpeteği Filtresi, Renk Filtresi, Kamaşma Önleyici ve Vizör aksesuar seçenekleri uygulanabilir.
- Orta, Geniş ve Çok Geniş reflektör açısı seçenekleri mevcuttur.
- 71lm/W'a varan verim.

Silindir 40

Silindir 40 Short Arm / I01.MLT.91202



* Code example / Kod örneği:

I01.MLT.91202 . 10 . 827 . SP . 01

- 1- Product code / Armatür kodu
- 2- Power / Güç
- 3- CRI / Kelvin
- 4- Reflector angle / Reflektör açısı
- 5- Colour / Ürün renk

Power / Güç	CRI	Order Code / Sipariş Kodu	Kelvin	Lümen T _c =50° Lümen
10W	CRI>90	I01.MLT.91202 . (..) . (...) . (..) . (..)	2700K	1093
			3000K	1115
			3500K	1137
			4000K	1159
			5000K	X
CRI>98	I01.MLT.91202 . (..) . (...) . (..) . (..)	2700K	747	
		3000K	769	
		4000K	800	

2	Watt - Driving Current / Watt - Sürüş Akımı	3		4		5			
		CRI / Kelvin		Reflector Angle / Reflektör Açısı		Product Color / Ürün Renk			
10	10W - 250mA	927	CRI>90 - 2700K	9827	CRI>98 - 2700K	ME	30° - Medium	01	white
		930	CRI>90 - 3000K	9830	CRI>98 - 3000K	FL	40° - Flood	02	ral 9010
		935	CRI>90 - 3500K	9840	CRI>98 - 4000K	WF	60° - Wide Flood	03	black
		940	CRI>90 - 4000K					04	gray
							05	dark gray	
							06	special color	

Silindir 40 Long Arm / I01.MLT.92202



* Code example / Kod örneği:

I01.MLT.92202 . 10 . 827 . SP . 01

- 1- Product code / Armatür kodu
- 2- Power / Güç
- 3- CRI / Kelvin
- 4- Reflector angle / Reflektör açısı
- 5- Colour / Ürün renk

Power / Güç	CRI	Order Code / Sipariş Kodu	Kelvin	Lümen T _c =50° Lümen
10W	CRI>90	I01.MLT.92202 . (..) . (...) . (..) . (..)	2700K	1093
			3000K	1115
			3500K	1137
			4000K	1159
			5000K	X
CRI>98	I01.MLT.92202 . (..) . (...) . (..) . (..)	2700K	747	
		3000K	769	
		4000K	800	

2	Watt - Driving Current / Watt - Sürüş Akımı	3		4		5			
		CRI / Kelvin		Reflector Angle / Reflektör Açısı		Product Color / Ürün Renk			
10	15W - 250mA	927	CRI>90 - 2700K	9827	CRI>98 - 2700K	ME	30° - Medium	01	white
		930	CRI>90 - 3000K	9830	CRI>98 - 3000K	FL	40° - Flood	02	ral 9010
		935	CRI>90 - 3500K	9840	CRI>98 - 4000K	WF	60° - Wide Flood	03	black
		940	CRI>90 - 4000K					04	gray
							05	dark gray	
							06	special color	